

ADAPT™ PREMIUM CONDENSING TANKLESS WITH X3™ SCALE PREVENTION TECHNOLOGY & INTEGRATED RECIRC PUMP

Introducing A. O. Smith's ADAPT™ premium condensing gas tankless water heaters, delivering robust, on-demand performance and the flexibility to install in practically any residential setting.

FEATURES:

X3™ SCALE PREVENTION TECHNOLOGY (PATENTED DESIGN)

- Units maintain like-new performance longer and life extended by up to 3x versus unprotected units
- Eliminates need for annual descaling
- Included with all X3 models, optional accessory for M (bypass) models

HEAVY-DUTY STAINLESS STEEL HEAT EXCHANGER DESIGN

- Single heavy-duty stainless steel heat exchanger design minimizes internal welds and improves overall reliability
- More resilient to scale buildup and corrosion

INTEGRATED RECIRCULATION PUMP & DISPLAY

- Integrated recirculation pump
- Built-in Control Display to set and review recirc schedules, status, and error codes

PERFORMANCE & EFFICIENCY

- 160,000, 180,000, 199,000 BTU/h models
- 9,000 BTU/h min. input
- 22:1 turndown ratio on 199,000 BTU/h models
- 10.5 GPM maximum flow rate
- 0.4 GPM activation flow rate
- 0.95 UEF, ENERGY STAR® certified
- Ultra Low NOx: NOx emissions less than 14 ng/J or 20 ppm for natural gas and less than 77 ppm for propane

ULTIMATE FLEXIBILITY EASE OF INSTALLATION

- Field convertible from natural gas to LP (kit included with unit)
- Vent up to 75' (23 m) with 2" pipe or up to 150' (46 m) with 3" pipe
- Cat. IV venting may be used
- Vent with ULC S636 certified PVC, CPVC, or polypropylene pipe
- X3 models include pressure relief valve
- Outdoor rated power cord standard on every unit
- Cascade up to 12 units (cable included with unit)

LIMITED WARRANTY

- No hard water exclusions on X3 models (exclusions apply to M models even with the addition of the optional X3 cartridge)
- 15-year limited warranty on heat exchanger in residential applications
- 5-year limited warranty on all parts in residential applications
- 1-year limited warranty on heat exchanger and parts in commercial applications



**ATHR-160X3, ATHR-180X3,
ATHR-199X3**
X3 Scale Prevention
Technology included



**ATHR-160M, ATHR-180M,
ATHR-199M**
X3 Scale Prevention Technology
can be added at any time
(optional accessory)



CSA/ANSI Z21.10.3 • CSA 4.3



COMMERCIAL-GRADE RESIDENTIAL GAS WATER HEATERS

		ATHR-160M	ATHR-160X3	ATHR-180M	ATHR-180X3	ATHR-199M	ATHR-199X3
Installation Type		Indoor / Outdoor*		Indoor / Outdoor*		Indoor / Outdoor*	
X3™ Scale Prevention Technology		Optional Accessory	Included	Optional Accessory	Included	Optional Accessory	Integrated
Recirculation Pump		Integrated					
Input Rate	Minimum	9,000 BTU/h					
	Maximum	160,000 BTU/h		180,000 BTU/h		199,000 BTU/h	
Fuel Type		Natural Gas (Field Convertible to Liquid Propane, Kit Included)					
Heat Exchanger		Stainless Steel					
Uniform Energy Factor (UEF)		0.95					
Maximum Flow Rate**		10.5 GPM					
Activation Flow Rate		0.4 GPM					
Continuous Fire Flow Rate		0.26 GPM					
Water Pressure Min. - Max.		15 - 150 PSI (40 PSI Recommended for Maximum Flow)					
Supply Gas Pressure (NG)	Min. in W.C. (kPa)	3.5 (0.9)					
	Max. in W.C. (kPa)	10.5 (2.6)					
Supply Gas Pressure (LP)	Min. in W.C. (kPa)	8.0 (2)					
	Max. in W.C. (kPa)	13.0 (3.2)					
Hot/Cold Connections		3/4" NPT					
Gas Connection		1/2" NPT					
Temperature Settings Min. - Max.		100°F (38°C) - 140°F (60°C); Default 120°F (49°C)					
Ignition System		Electronic Ignition					
Power Supply		120V, 50Hz/60Hz, <5A					
Sound Level		50.3 dB**					
Elevation		Certified from Sea Level to 10,100' (3,078.5 m)					
Freeze Protection*		- 5°F (-21°C)					
Venting - Exhaust, Intake	Type	Power Direct Vent					
	Size, Max Run	2", 75' (5 cm, 22.9 m); 3", 150' (8 cm, 45.7 m)					
	Material	ULC S636 certified PVC, CPVC, or polypropylene					
Unit Dimensions	Height***	33.8" (86 cm)	44.6" (113 cm)	33.8" (86 cm)	44.6" (113 cm)	33.8" (86 cm)	44.6" (113 cm)
	Width	16.5" (42 cm)					
	Depth	16.1" (41 cm)					
	Weight	104 lb. (47 kg)					
Shipping Dimensions****	Height	20.8" (53 cm)					
	Width	22.3" (57 cm)					
	Depth	40" (102 cm)					
	Weight	125 lb (57 kg)					

All models are ENERGY STAR® certified.

* Outdoor installations require outdoor vent cap kit (100369060) sold separately.

** Based on factory settings.

*** Height from flue collar to top of X3 scale control media cartridge on X3 models and to top of manifold cartridge on M models.

**** Packaged and shipped on unit back.

*Internal freeze protection for heater only; Freeze protection for the X3 and bypass cartridges (kits sold separately) is recommended for outdoor installations.

Included with Heater: Manual, Pressure Relief Valve (X3 models only), Wall Mounting Bracket and Hardware, Vent Port Screws, Cascading Cable, Fuel Conversion Kit, Bird Screens

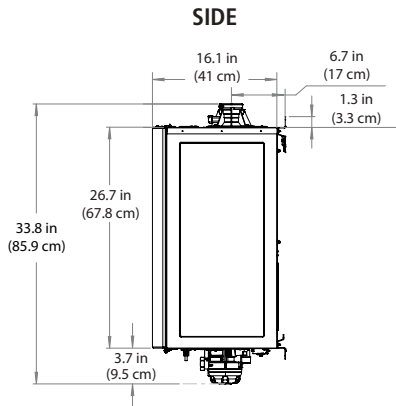
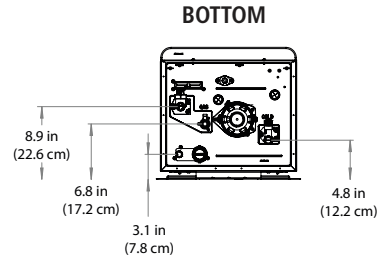
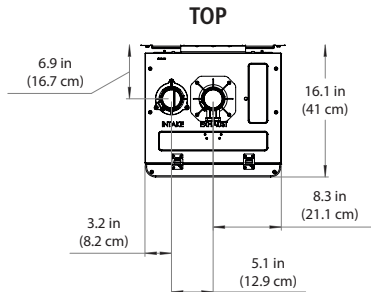
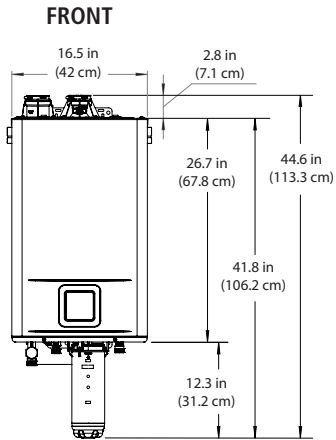

PUMP PERFORMANCE

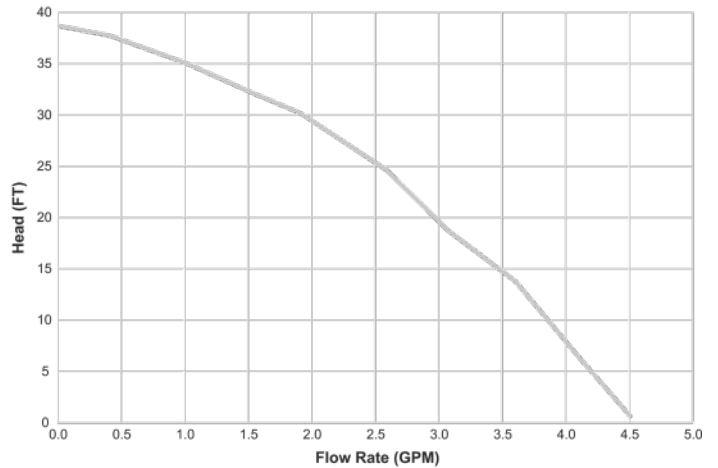



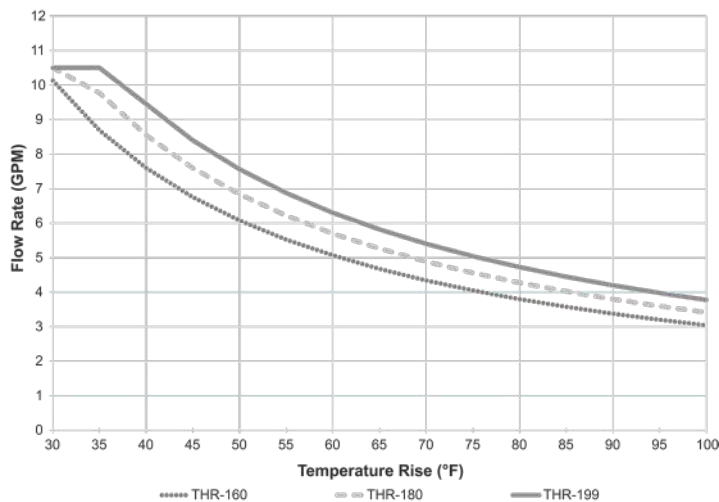



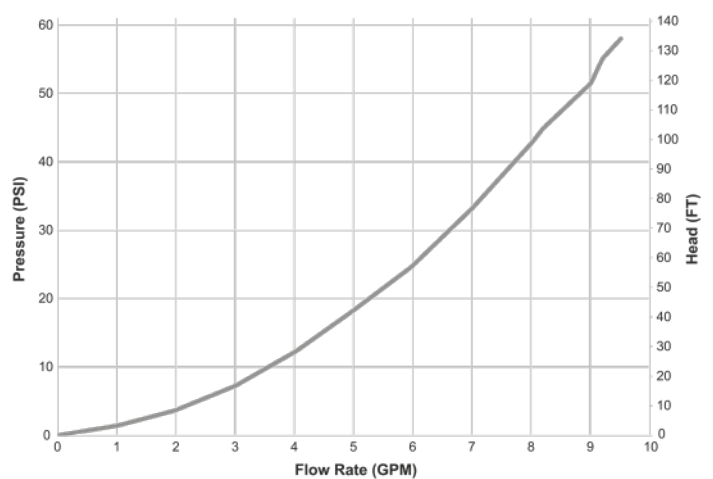

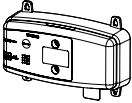
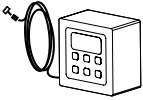

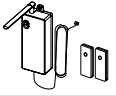
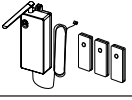
FLOW RATE

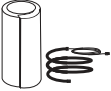

PRESSURE LOSS

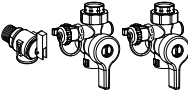

Item	Material Number		Description
X3 Cartridge	100368986		Add to an M model heater to prevent scale buildup and eliminate the need for annual descaling.
Wi-Fi Module Kit	100371922		Wi-Fi Module for electronically connecting tankless water heaters to the internet and adapter to connect to the water heater. Kit contains: Module (1x), Cable (1x), Adapter (1x)
Remote Temperature Controller	100377310		Remote Temperature Controller with 10' (3 m) cable.
Communication Cable - 10' (3 m)	100377341		Replacement 10' (3 m) Communication Cable for Remote Temperature Controller, WiFi Module, or On-Demand Receiver.
Communication Cable - 32' (10 m)	100377342		Extended 32' (10 m) Communication Cable for Remote Temperature Controller, WiFi Module, or On-Demand Receiver.
Remote Recirculation Kit - Two Buttons	100371920		Remote Recirculation Kit activates the water heater and recirculation at a touch of a button for on-demand hot water. Kit contains: Receiver (1x), Buttons (x2)
Remote Recirculation Kit - Three Buttons	100371921		Remote Recirculation Kit activates the water heater and recirculation at a touch of a button for on-demand hot water. Kit contains: Receiver (1x), Buttons (x3)
Individual Spare Button	100377309		Add Remote Recirculation Buttons to a system to a maximum of 30.
X3 Freeze Protection (X3 Models)	100325654		Freeze Protection for the X3 cartridge for outdoor installations. Cartridge is not protected by the water heater's internal freeze protection.
Bypass Freeze Protection (M Models)	100371918		Freeze Protection for the bypass cartridge for outdoor installations. Cartridge is not protected by the water heater's internal freeze protection.
Pipe Cover	100374697		Pipe Cover protects plumbing connections to the heater while improving the appearance of the installation. Affixes to bottom of heater.
Neutralizer Assembly Kit	100112159		Neutralizer Assembly neutralizes the condensate (acidic water) that forms in the heat exchanger of the water heater. It connects to the condensate drain port of the water heater by using connectors included with the neutralizer kit.
Outdoor Vent Cap Kit	100369060		Vent cap kit and accessories for installing the tankless heater outdoors. Kit contains: Vent Cap (1x), User Interface Overlay (1x)
Isolation Valve Kit with Pressure Relief Valve	100112156		Isolation Valves help control water flow during routine maintenance. Pressure Relief Valve limits pressure in the water heater. X3 models include a pressure relief valve.
Cross Over Valve Kit	100327167		For systems without a dedicated return line necessary. Install at the faucet furthest from the hot water heater.

For Technical Information, call 888-599-2837. A. O. Smith Enterprises Ltd. reserves the right to make product changes or improvements without prior notice.