

INSTALLATION - OPERATION  
MAINTENANCE - SERVICE - TROUBLESHOOTING



Thank you for buying this energy efficient water heater. We appreciate your confidence in our products.

**! WARNING**



Read and understand this instruction manual and the safety messages herein before installing, operating or servicing this water heater.

Failure to follow these instructions and safety messages could result in death or serious injury.

This manual must remain with the water heater.

**! WARNING**

**Electrical Shock Hazard**



If the water heater becomes immersed in water up to or above the level of the bottom of the element doors, the heater should be examined by a qualified service agency before it is placed in operation.

PLACE THESE INSTRUCTIONS ADJACENT TO HEATER AND NOTIFY OWNER TO KEEP FOR FUTURE REFERENCE.

**KEEP THIS MANUAL IN THE POCKET ON HEATER FOR FUTURE REFERENCE WHENEVER MAINTENANCE ADJUSTMENT OR SERVICE IS REQUIRED.**

# CONTENTS

APPROVALS .....	3	Electrical.....	18
GENERAL SAFETY INFORMATION.....	4	Branch Circuit.....	18
Do Not Use If Damaged .....	4	Calculating Amperage/Over-current Protection.....	18
Hydrogen Gas (Flammable).....	4	Electrical Connection Instructions .....	19
Hazard Messages .....	5	STARTUP .....	21
Hazard Messages .....	5	Filling the Water Heater.....	21
INTRODUCTION .....	8	Initial Start Up.....	21
Preparing for the Installation .....	8	Draining the Water Heater.....	21
FEATURES AND COMPONENTS.....	9	DRY FIRE DETECTION CIRCUIT .....	21
Components Left and Right Views.....	10	Defrost Cycle.....	21
INSTALLATION CONSIDERATIONS .....	12	TEMPERATURE REGULATION.....	22
Rough-In Dimensions.....	12	High Temperature Limit Control (ECO) .....	22
Locating the Water Heater .....	12	Thermostat Control .....	22
Room Size Requirement .....	13	High Temperature Applications .....	23
Service Clearances .....	14	SYSTEM OPERATION .....	24
Insulation Blankets .....	14	Operating Modes.....	24
WATER HEATER INSTALLATION.....	15	Control System Navigation.....	24
Required Ability .....	15	MAINTENANCE .....	33
General .....	15	Anode Rod Maintenance.....	33
Thermostatic Point-of-Use Mixing Valves .....	15	Sediment Removal.....	34
Dish-washing Machines .....	16	Heating Element Replacement .....	34
Contaminated Water .....	16	Temperature-Pressure Relief Valve Test .....	35
Recirculating Loop .....	16	TROUBLESHOOTING .....	36
Hard Water.....	16	Checklist.....	36
Water Outlet Tube .....	16	Fault and Alert Conditions .....	37
Temperature-Pressure Relief Valve .....	16	DIAGRAMS .....	40
Closed Water Systems.....	17	Wiring Diagrams.....	40
Thermal Expansion .....	17	Piping Diagram.....	42
Condensate Drain Line Installation .....	18		

# APPROVALS

All models are listed by Underwriters Laboratories Inc.



Low Lead Content

# GENERAL SAFETY INFORMATION

## DO NOT USE IF DAMAGED

**DO NOT USE THIS WATER HEATER IF ANY PART HAS BEEN EXPOSED TO FLOODING OR WATER DAMAGE.** Immediately call a qualified service technician to inspect the water heater and to replace any part of the control system which has been under water.

If the unit is exposed to the following, do not operate heater until all corrective steps have been made by a qualified service technician.

1. External fire.
2. Damage.
3. Firing without water.

### Grounding Instructions

This water heater must be grounded in accordance with the National Electrical Code and/or local codes. These must be followed in all cases. Failure to ground this water heater properly may also cause erratic control system operation on the **ELECTRONIC CONTROL**.

This water heater must be connected to a grounded metal, permanent wiring system; or an equipment grounding conductor must be run with the circuit conductors and connected to the equipment grounding terminal or lead on the water heater.

## HYDROGEN GAS (FLAMMABLE)

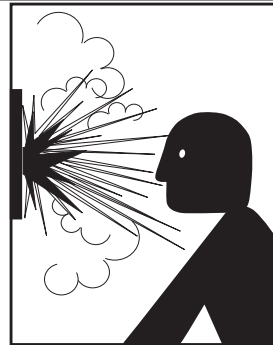

## **⚠️ WARNING**

### Explosion Hazard

- Flammable hydrogen gases may be present.
- Keep all ignition sources away from faucet when turning on hot water.

Hydrogen gas can be produced in a hot water system served by this heater that has not been used for a long period of time (generally two weeks or more). Hydrogen gas is extremely flammable. To reduce the risk of injury under these conditions, it is recommended that the hot water faucet be opened for several minutes at the kitchen sink before using any electrical appliance connected to the hot water system. If hydrogen is present there will probably be an unusual sound such as air escaping through the pipe as the water begins to flow. **THERE SHOULD BE NO SMOKING OR OPEN FLAME NEAR THE FAUCET AT THE TIME IT IS OPEN.**

Verify the power to the water heater is turned off before opening the control panel or performing any service procedures.

## IMPORTANT DEFINITIONS

### • Qualified Installer or Service Agency:

Installation and service of this water heater requires ability equivalent to that of a Qualified Agency (as defined by ANSI below) in the field involved. Installation skills such as plumbing, electrical supply are required in addition to electrical testing skills when performing service.

### • ANSI Z223.1 2006 Sec. 3.3.83:

“Qualified Agency” - “Any individual, firm, corporation or company that either in person or through a representative is engaged in and is responsible for (a) the installation, testing or replacement of gas piping or (b) the connection, installation, testing, repair or servicing of appliances and equipment; that is experienced in such work; that is familiar with all precautions required; and that has complied with all the requirements of the authority having jurisdiction.”







**HAZARD MESSAGES**

The proper installation, use and servicing of this water heater is extremely important to your safety and the safety of others.

Many safety-related messages and instructions have been provided in this manual and on your own water heater to warn you and others

of a potential injury hazard. Read and obey all safety messages and instructions throughout this manual. It is very important that the meaning of each safety message is understood by you and others who install, use, or service this water heater.

	This is the safety alert symbol. It is used to alert you to potential personal injury hazards. Obey all safety messages that follow this symbol to avoid possible injury or death.
---	--



	DANGER indicates an imminently hazardous situation which, if not avoided, will result in injury or death.
	WARNING indicates a potentially hazardous situation which, if not avoided, could result in injury or death.
	CAUTION indicates a potentially hazardous situation which, if not avoided, could result in minor or moderate injury.
	CAUTION used without the safety alert symbol indicates a potentially hazardous situation which, if not avoided, could result in property damage.

All safety messages will generally tell you about the type of hazard, what can happen if you do not follow the safety message, and how to avoid the risk of injury.

**HAZARD MESSAGES**

	
	Read and understand this instruction manual and the safety messages herein before installing, operating or servicing this water heater.
	Failure to follow these instructions and safety messages could result in death or serious injury. This manual must remain with the water heater.

	
<b>Improper installation, use and service may result in property damage.</b>	
<ul style="list-style-type: none"> <li>• Do not operate water heater if exposed to flooding or water damage.</li> <li>• Inspect anode rods regularly, replace if damaged.</li> <li>• Install in location with drainage.</li> <li>• Fill tank with water before operation.</li> <li>• Properly sized thermal expansion tanks are required on all closed water systems.</li> </ul> <p style="text-align: center;">Refer to this manual for installation and service.</p>	

	
<b>Electrical Shock Hazard</b>	
	If the water heater becomes immersed in water up to or above the level of the bottom of the element doors, the heater should be examined by a qualified service agency before it is placed in operation.

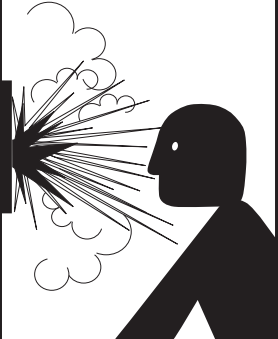

<b>⚠ WARNING</b>
<b>Explosion Hazard</b>
<ul style="list-style-type: none"> <li>• Flammable hydrogen gases may be present.</li> <li>• Keep all ignition sources away from faucet when turning on hot water.</li> </ul>

<b>⚠ WARNING</b>
<b>Electrical Shock Hazard</b>
 <ul style="list-style-type: none"> <li>• Before removing any access panels or servicing the water heater, make sure the electrical supply to the water heater is turned OFF.</li> <li>• Failure to follow these instructions can result in personal injury or death.</li> </ul>

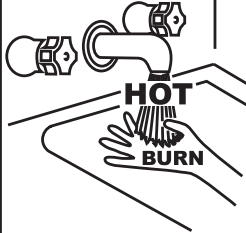

<b>⚠ WARNING</b>
<b>Burn Hazard</b>
<ul style="list-style-type: none"> <li>• Do not connect the water heater to the power supply, unless the tank has been completely filled with water and a T&amp;P valve has been installed.</li> <li>• Water temperature over 125°F (52°C) can cause severe burns instantly or death from scalds. Children, the disabled and elderly are at highest risk of being scalded. Feel water temperature before bathing or showering.</li> </ul>

<b>CAUTION</b>
<b>Property Damage Hazard</b>
<ul style="list-style-type: none"> <li>• All water heaters eventually leak.</li> <li>• Do not install without adequate drainage.</li> </ul>

<b>CAUTION</b>
<b>Property Damage Hazard</b>
To avoid water heater damage, fill tank with water before operating.

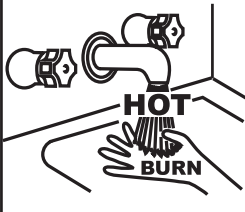

<b>⚠ WARNING</b>
<b>Burn Hazard</b>
If you choose a higher temperature setting, install thermostatic mixing valves at each point-of-use to help avoid scalding.

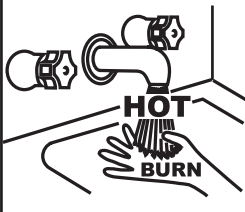

<b>⚠ WARNING</b>
<b>Burn Hazard</b>
To reduce the risk of unusually hot water reaching the fixtures in the house, install thermostatic mixing valves at each point of use.

<b>⚠ WARNING</b>
<b>Toxic Chemical Hazard</b>
<ul style="list-style-type: none"> <li>• Do not connect to non-potable water system.</li> </ul>

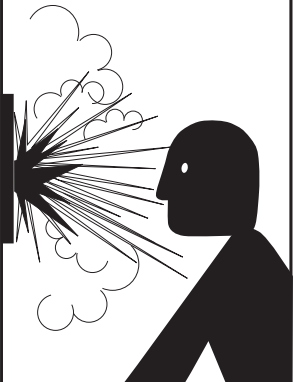

<b>⚠ WARNING</b>
<b>Explosion Hazard</b>
<ul style="list-style-type: none"> <li>• Temperature-Pressure Relief Valve must comply with <i>ANSI Z21.22-CSA 4.4</i> and <i>ASME</i> code.</li> <li>• Properly sized temperature-pressure relief valve must be installed in opening provided.</li> <li>• Can result in overheating and excessive tank pressure.</li> <li>• Can cause serious injury or death.</li> </ul>

<b>CAUTION</b>
<b>Property Damage Hazard</b>
<ul style="list-style-type: none"> <li>• The temperature-pressure relief-valve discharge pipe must terminate at an adequate drain.</li> </ul>

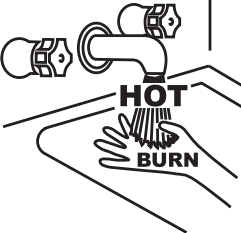
	<b>⚠ WARNING</b>
	<b>Burn Hazard</b>
	<ul style="list-style-type: none"> <li>Do not connect the water heater to the power supply, unless the tank has been completely filled with water and a T&amp;P valve has been installed.</li> <li>Water temperature over 125°F (52°C) can cause severe burns instantly or death from scalds. Children, the disabled and elderly are at highest risk of being scalded. Feel water temperature before bathing or showering.</li> </ul>

<b>CAUTION</b>
<b>Property Damage Hazard</b>
<p>To avoid water heater damage, fill tank with water before operating.</p>

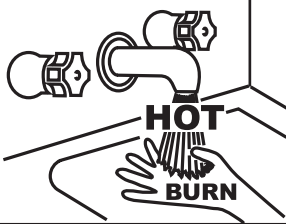
	<b>⚠ DANGER</b>
	<ul style="list-style-type: none"> <li>Burn hazard.</li> <li>Hot water discharge.</li> <li>Keep hands clear of drain valve discharge.</li> </ul>

<b>CAUTION</b>
<b>Improper installation, use and service may result in property damage.</b>
<ul style="list-style-type: none"> <li>Do not operate water heater if exposed to flooding or water damage.</li> <li>Inspect anode rods regularly, replace if damaged.</li> <li>Install in location with drainage.</li> <li>Fill tank with water before operation.</li> <li>Properly sized thermal expansion tanks are required on all closed water systems.</li> </ul> <p style="text-align: center;">Refer to this manual for installation and service.</p>

<b>CAUTION</b>
<b>Property Damage Hazard</b>
<ul style="list-style-type: none"> <li>The temperature-pressure relief-valve discharge pipe must terminate at an adequate drain.</li> </ul>

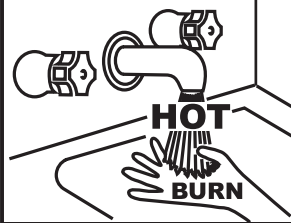
	<b>⚠ DANGER</b>
	<ul style="list-style-type: none"> <li>Burn hazard.</li> <li>Hot water discharge.</li> <li>Keep clear of Temperature-Pressure Relief Valve discharge outlet.</li> </ul>

<b>CAUTION</b>
<b>Property Damage Hazard</b>
<ul style="list-style-type: none"> <li>Avoid damage.</li> <li>Inspection and replacement of anode rod required.</li> </ul>

	<b>⚠ WARNING</b>
	<b>Electrical Shock Hazard</b>
	<ul style="list-style-type: none"> <li>Turn off power at the branch circuit breaker serving the water heater before performing any service.</li> <li>Label all wires prior to disconnecting when performing service. Wiring errors can cause improper and dangerous operation.</li> <li>Verify proper operation after servicing.</li> <li>Failure to follow these instructions can result in personal injury or death.</li> </ul>

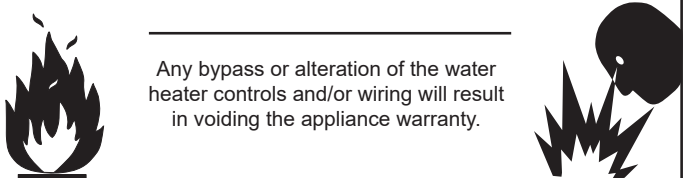
<b>⚠ WARNING</b>
<b>Jumping out control circuits or components can result in property damage, personal injury or death.</b>
<ul style="list-style-type: none"> <li>Service should only be performed by a qualified service technician using proper test equipment.</li> <li>Altering the water heater controls and/or wiring in any way could result in permanent damage to the controls or water heater and is not covered under the limited warranty.</li> </ul>
 <p style="text-align: center;">Any bypass or alteration of the water heater controls and/or wiring will result in voiding the appliance warranty.</p>



# INTRODUCTION

**Thank You** for purchasing this water heater. Properly installed and maintained, it should give you years of trouble free service.

Abbreviations Found In This Instruction Manual:

- ANSI - American National Standards Institute
- ASME - American Society of Mechanical Engineers
- NEC - National Electrical Code
- NFPA - National Fire Protection Association
- UL - Underwriters Laboratory
- CSA - Canadian Standards Association

## PREPARING FOR THE INSTALLATION

 <b>WARNING</b>	
	<b>Electrical Shock Hazard</b>
	<ul style="list-style-type: none"><li>• Before removing any access panels or servicing the water heater, make sure the electrical supply to the water heater is turned OFF.</li><li>• Failure to follow these instructions can result in personal injury or death.</li></ul>

1. Read the “General Safety Information” section of this manual first and then the entire manual carefully. If you don’t follow the safety rules, the water heater may not operate safely. It could cause **DEATH, SERIOUS BODILY INJURY AND/OR PROPERTY DAMAGE**.

This manual contains instructions for the installation, operation, and maintenance of the heat pump water heater. It also contains warnings throughout the manual that you must read and be aware of. All warnings and all instructions are essential to the proper operation of the water heater and your safety. **READ THE ENTIRE MANUAL BEFORE ATTEMPTING TO INSTALL OR OPERATE THE WATER HEATER.**

Be sure to turn off power when working on or near the electrical system of the heater. Never touch electrical components with wet hands or when standing in water. When replacing fuses always use the correct size for the circuit.

The model and rating plates interpret certain markings into useful

information. Both of these references should be used to identify the heater, its components and optional equipment.

2. The installation must conform with these instructions and the local code authority having jurisdiction and the requirements of the power company. In the absence of local codes, the installation must comply with the latest editions of the **National Electrical Code, NFPA 70** or the **Canadian Electrical Code CSA C22.1**. The **National Electrical Code** may be ordered from: National Fire Protection Association, 1 Batterymarch Park, Quincy, MA 02269. The Canadian Electrical Code is available from the Canadian Standards Association, 8501 East Pleasant Valley Road, Independence, OH 44131.
3. If after reading this manual you have any questions or do not understand any portion of the instructions, call the toll free number listed on the back cover of this manual for technical assistance.  
  
In order to expedite your request, please have full model and serial number available for the technician.
4. Carefully plan your intended placement of the water heater. Examine the location to ensure the water heater complies with the “Locating the New Water Heater” section in this manual.

Installation and service of this water heater requires ability equivalent to that of a licensed tradesman or qualified agency in the field involved. Plumbing and electrical work are required.

5. For installation in California, this water heater must be braced or anchored to avoid falling or moving during an earth quake. See instructions for correct installation procedures. Instructions may be obtained from California Office of the State Architect, 1102 Q Street Suite 5100, Sacramento, CA, 95811
6. Massachusetts Code requires this water heater to be installed in accordance with Massachusetts 248-CMR 2.00: State Plumbing Code and 248-CMR5. See Installing Carbon Monoxide Detectors .

**Important:** The heat pump portion of this water heater uses R-134a refrigerant. Any disposal of refrigerants shall follow any state and local codes regarding refrigerants.

# FEATURES AND COMPONENTS

## COMPONENTS FRONT AND TOP

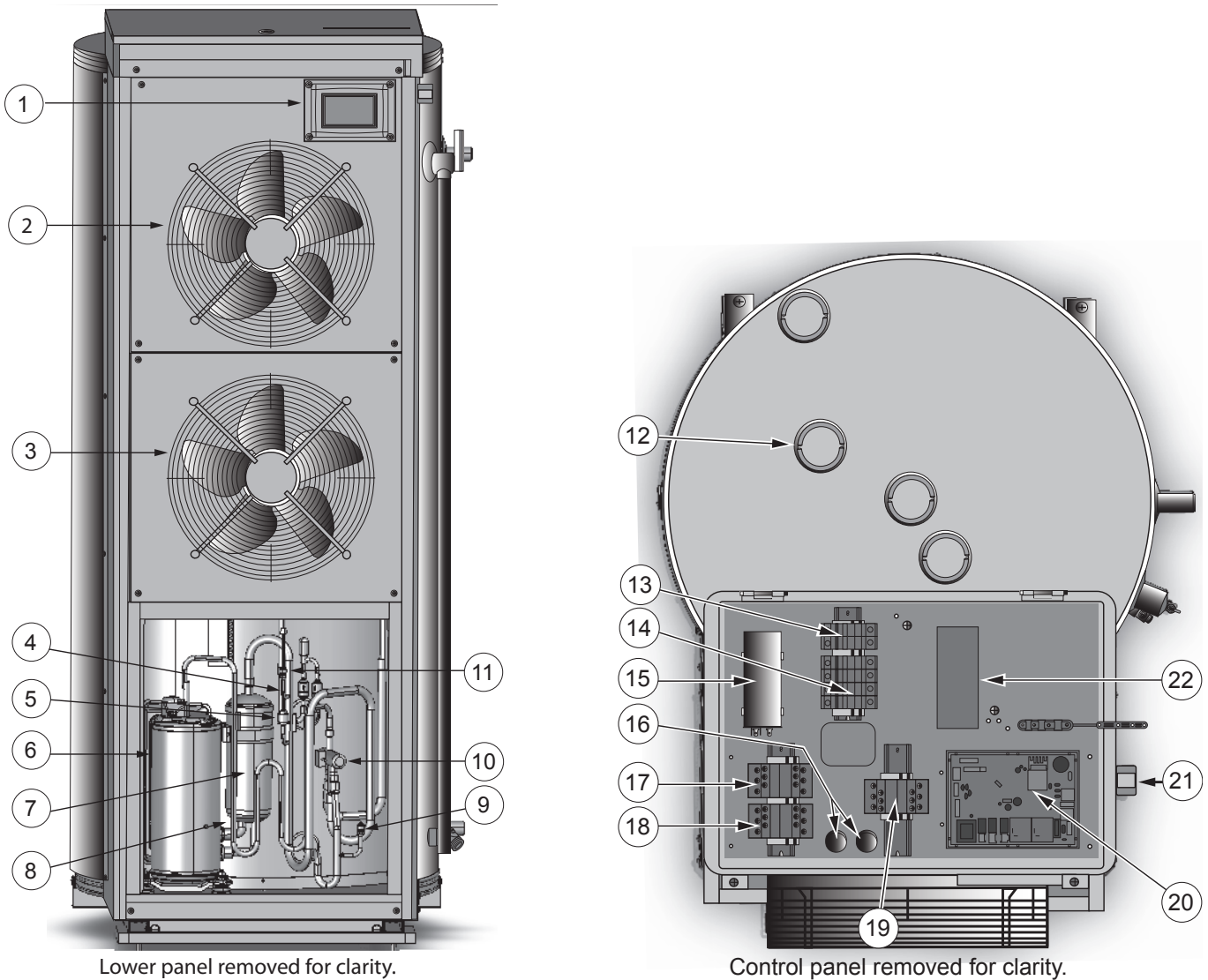

**Figure 1. Front and Top View**

- |   |   |
|---|---|
| 1. User Interface Module (UIM). The UIM includes the display circuit board and control system's LCD Touch Display. Used to adjust various user settings and view operational information. | 12. Anode. (Located beneath plastic cap)                                |
| 2. Upper Evaporator Fan   | 13. Fuses and Extractor Type Fuse Holders for Compressor                |
| 3. Lower Evaporator Fan   | 14. Fuses and Extractor Type Fuse Holders for Upper and Lower Elements. |
| 4. Suction Temperature Sensor (Located on Tubing)   | 15. Capacitor, Compressor   |
| 5. Electronic Expansion Valve Coil (EEV)  | 16. Capacitor, Upper/Lower Fans   |
| 6. Compressor   | 17. Contactor, Upper Element  |
| 7. Accumulator  | 18. Contactor, Lower Element  |
| 8. Discharge Temperature Sensor (located on tubing, not shown)  | 19. Contactor, Compressor   |
| 9. Refrigerant High Pressure Port   | 20. Main Control Board (CCB)  |
| 10. 4-Way Valve   | 21. Electrical Conduit Access Port                                      |
| 11. Refrigerant Low Pressure Port   | 22. Terminal Block  |

**COMPONENTS LEFT AND RIGHT VIEWS**

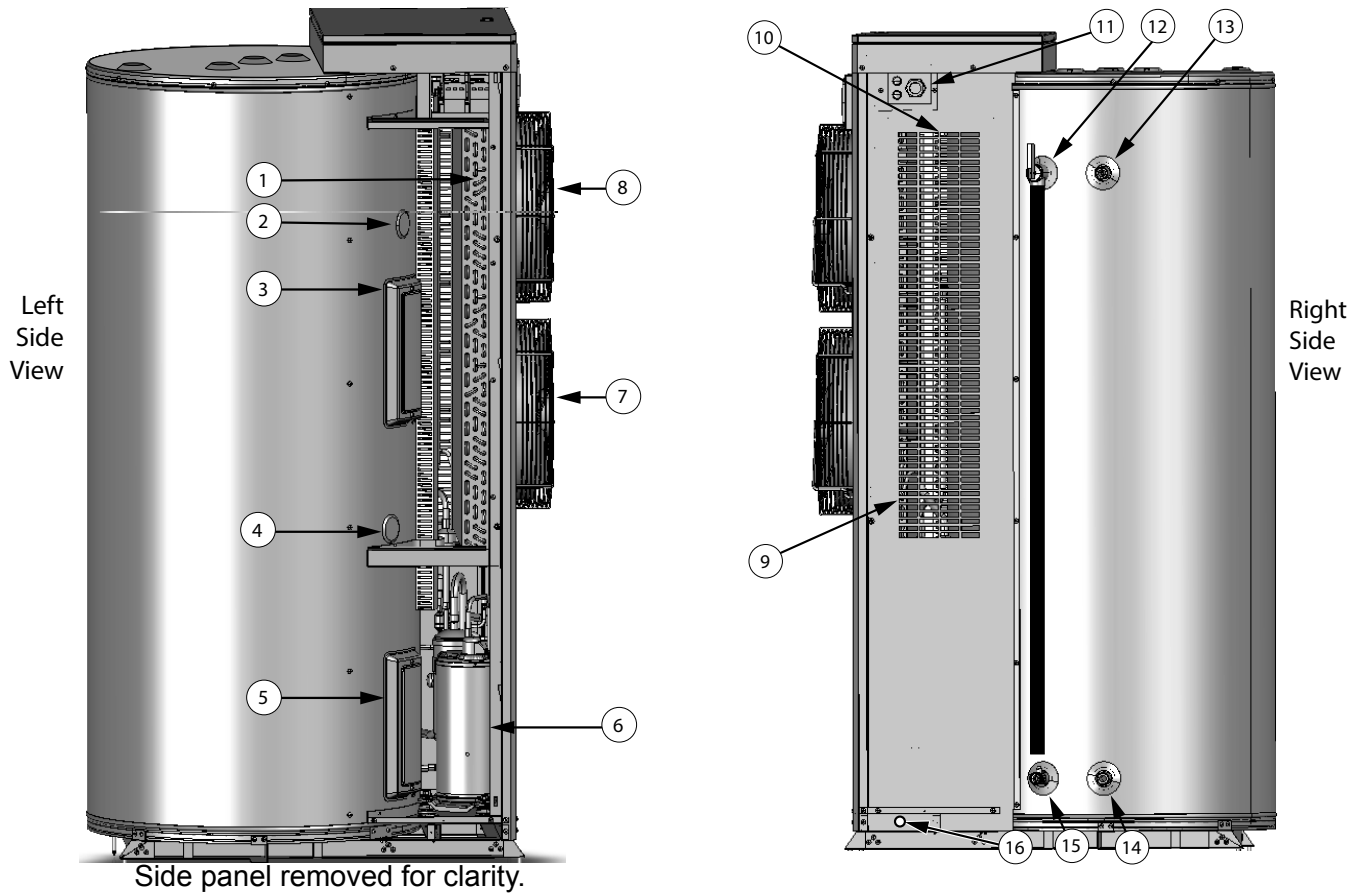

**Figure 2. Left and Right Side Views**

- |   |  |
|---|--|
| <ol style="list-style-type: none"> <li>1. Evaporator</li> <li>2. Upper Tank Temperature Sensor (located beneath plastic cap)</li> <li>3. Upper Heating Element, ECO, Mid-Upper Tank Temperature Sensor (Located behind panel).</li> <li>4. Mid-Lower Tank Temperature Sensor (located beneath plastic cap)</li> <li>5. Lower Heating Element, ECO, Lower Tank Temperature Sensor (Located behind panel).</li> <li>6. Compressor</li> <li>7. Lower Evaporator Fan</li> </ol> | <ol style="list-style-type: none"> <li>8. Upper Evaporator Fan</li> <li>9. Coil Temperature Sensor (located behind side panel on evaporator coil)</li> <li>10. Ambient Air Sensor (Located behind side panel)</li> <li>11. Electrical Conduit Access Port</li> <li>12. Temperature-Pressure Relief Valve</li> <li>13. Water Outlet Tube (3/4" NPT Connection)</li> <li>14. Water Inlet (3/4" NPT Connection)</li> <li>15. Drain Valve</li> <li>16. Condensate Drain Tube (Not Shown). Exits from under panel.</li> </ol> |
|---|--|

Table 1. Technical Characteristics		
Model Type	Integrated Heat Pump Water Heater	
COP	4.2	
HP Rated Input Power	3.15 HP (2.35 kW)	
HP Rated Heating Output Capacity	11.13 kW	
Power Specification	208/240Vac ~ 60Hz 1Ph	
Maximum Operation Current	67 A	
Refrigerant	R134a	
Refrigerant Charge Quantity	3.3 Lbs (1.5 Kg)	
Electrical Heating Capacity	12.0 kW	
Measured Tank Capacity	111.76 Gal (423 L)	
Operation Modes	Efficiency, Hybrid, Electric	
Max. Water Temperature	Efficiency/Hybrid	Electric
	150°F (66°C)	180°F (82°C)
Operating Ambient Temperature	20 - 110°F (-6.6 - 43.3°C)	
Unit Operation Noise	59 dB (A)	
Approx. Heater Weight	498 Lbs (226 Kg)	
Approx. Shipping Weight	620 Lbs (281 Kg)	

Table 2. Recovery Rate In Gallons Per Hour															
Mode of Operation	Input		Temperature Rise °F												
	Btu/hr	kW	°F	30°F	40°F	50°F	60°F	70°F	80°F	90°F	100°F	110°F	120°F	130°F	140°F
			°C	17°C	22°C	28°C	33°C	39°C	44°C	50°C	56°C	61°C	67°C	72°C	78°C
Efficiency	33,678	9.87	GPH	136	102	82	68	58	51	45	41	37	34	31	29
			LPH	515	386	309	258	221	193	172	155	140	129	119	110
Hybrid	74,624	21.87	GPH	302	226	181	151	129	113	101	90	82	75	70	65
			LPH	1141	856	685	571	489	428	380	342	311	285	263	245
Electric	40,946	12	GPH	165	124	99	83	71	62	55	50	45	41	38	35
			LPH	626	470	376	313	268	235	209	188	171	157	145	134



# INSTALLATION CONSIDERATIONS

## ROUGH-IN DIMENSIONS

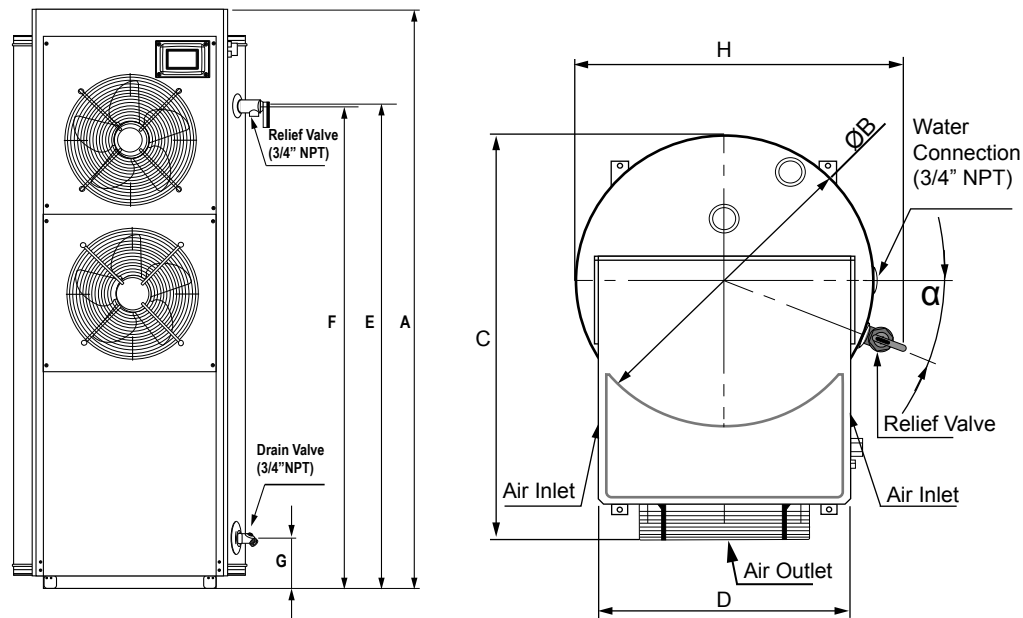

Figure 3. Rough-In Dimensions

Table 3. Physical Dimensions								
Total Height (A)	Tank Diameter (B)	Maximum Depth (C)	Service Panel Width (D)	Relief Valve Height (E)	Water Outlet Height (F)	Water Inlet Height (G)	Relief Valve Angle $\alpha$ (°)	Maximum Width (H)
69.68 in (1770 mm)	28.03 in (712 mm)	39.17 in. (995 mm)	23.62 in. (600 mm)	58.11 in. (1476 mm)	57.80 in (1468 mm)	6.02 in. (153 mm)	22	30.91 in. (785 mm)

## LOCATING THE WATER HEATER

Carefully choose a location for the new water heater. The placement is a very important consideration for the safety of the occupants in the building and for the most economical use of the water heater.

### CAUTION

#### Property Damage Hazard

- All water heaters eventually leak.
- Do not install without adequate drainage.

Whether replacing an existing water heater or installing the water heater in a new location, observe the following critical points.

**Important:** The water heater must have unrestricted airflow.

1. The water heater should be located indoors. If located outdoors, it must be under a shelter or in an alcove where it will be protected from the weather and other harsh elements.
2. The water heater must not be located in an area where it will be subject to freezing temperatures.
3. Locate the water heater so that it is protected and not subject

to physical damage by a moving vehicle.

4. Locate the water heater on a level surface.
5. Locate the water heater near a floor drain. The water heater should be located in an area where leakage of the tank or connections will not result in damage to the area adjacent to the water heater or to lower floors of the structure. When such locations cannot be avoided, it is recommended that a metal drain pan, adequately drained, be installed under the water heater.
6. Locate the water heater close to the point of major hot water usage.
7. Locate the water heater close to its electrical power supply.
8. Locate the water heater where an adequate supply of fresh air for ventilation can be obtained.

The site location must be free from any corrosive elements in the atmosphere such as sulfur, fluorine, and chlorine. These elements are found in aerosol sprays, detergents, bleaches, cleaning solvents, air fresheners, paint, and varnish removers, refrigerants, and many other commercial and household products. In addition, excessive dust and lint may affect the operation of the unit.



The ambient air temperature must also be considered when installing this unit. In Efficiency Mode the ambient air temperature must be above 45°F and below 109°F. If the ambient air temperature falls outside these upper and lower limits the electrical elements will activate to meet the hot water demand and the heat pump does

not operate.

The water heater should be located in an area where leakage of the tank or connections will not result in damage to the area adjacent to the heater or to lower floors of the structure.

**ROOM SIZE REQUIREMENT**

The water heater should have adequate space (clearances) for periodic servicing. For optimal water heater efficiency and performance, the water heater must have unrestricted airflow and is recommended to have a minimum installation space of approximately 3200 cubic feet. Installation spaces less than the recommended could result in reduced water heater efficiency and performance.

If the water heater is installed in a confined space with less than 3200 cubic feet, provisions should be made to ensure sufficient airflow,

such as installing louvered grills or fully louvered doors to ensure the most efficient operation of the water heater. See **Table 4**. Failure to do so could result in reduced heater efficiency and performance.

If the ambient air temperature in the installed location drops more than 15°F (8°C) during heating, air circulation is insufficient and could result in reduced water heater efficiency and performance. The side opposite to the fans should normally be left open with a minimum clearance of 36" (91 cm) to any obstacles.

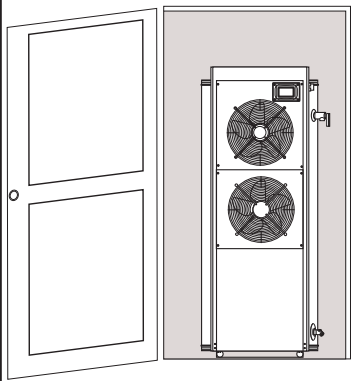
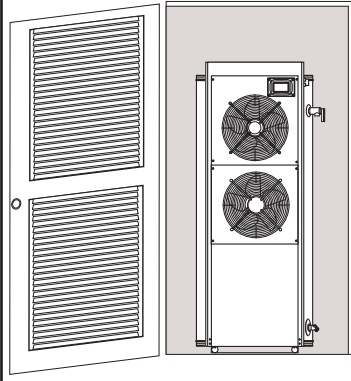
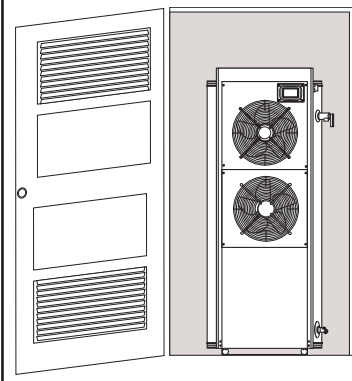
			
Configuration (See Note 1)	Enclosed Room (No louvers)	Fully Louvered Door or Wall Opening	Double Louvers in Wall or Door
Minimum Space (FT <sup>3</sup> )	3200	1600	1600
Space Example H x L x W (FT)	18 x 18 x 10	13 x 13 x 10	13 x 13 x 10
<ol style="list-style-type: none"> <li>1. Total minimum louver open area is 4 ft<sup>2</sup> or 576 in<sup>2</sup>.</li> <li>2. Installations less than the recommended room size could result in reduced water heater efficiency and performance.</li> <li>3. When two louvers are installed, install one louver at or near the top of the heater and the other one close to the bottom of the heater.</li> <li>4. Maintaining a room temperature above 50°F(10°C) helps to avoid the defrost cycle being activated and provides for better heater efficiency and performance.</li> </ol>			

## SERVICE CLEARANCES

---

A minimum clearance of 24" (61 cm) must be allowed for access to replaceable parts such as thermostats, drain valve and relief valve.

**Note:** Adequate clearance for servicing should be maintained on all installations.

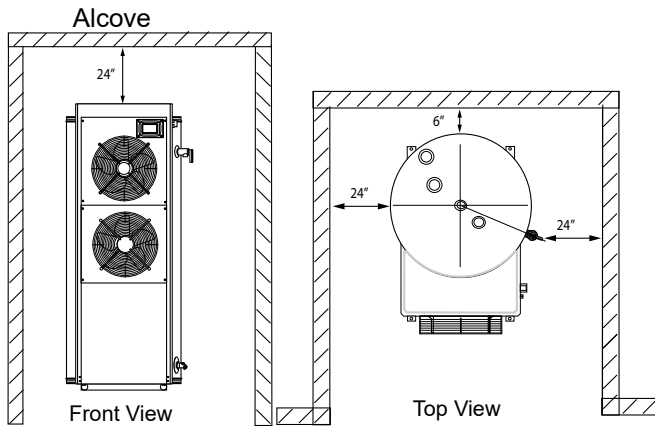

**Figure 4. Clearances**

A service clearance of 24 inches (61 cm) should be maintained from serviceable parts such as the T&P valve, control system components, drain valve, and anode. Leave as much space as possible above the water heater for this reason.

## INSULATION BLANKETS

---

The use of an insulation blanket on this water heater is not needed or recommended. The purpose of an insulation blanket is to reduce the standby heat loss encountered with storage tank heaters. Your water heater meets or exceeds the National Appliance Energy Conservation Act standards with respect to insulation and standby loss requirements, making an insulation blanket unnecessary.

# WATER HEATER INSTALLATION

## REQUIRED ABILITY

Installation and service of this water heater requires ability equivalent to that of a qualified installer or service agency in the field involved. Plumbing and electrical work is required.

## GENERAL

The installation must conform with these instructions and the local code authority having jurisdiction and the requirements of the power company. In the absence of local codes, the installation must comply with the latest editions of the National Electrical Code, NFPA 70 or the Canadian Electrical Code CSA C22.1. The National Electrical Code may be ordered from: National Fire Protection Association, 1 Batterymarch Park, Quincy, MA 02269. The Canadian Electrical Code is available from the Canadian Standards Association, 8501 East Pleasant Valley Road, Independence, OH 44131.

Do NOT test electrical system before heater is filled with water, follow the START UP procedure in the OPERATION section of this manual.

The principal components of the heater are identified in the *Features and Components* illustrations (page 9).

**⚠ DANGER**

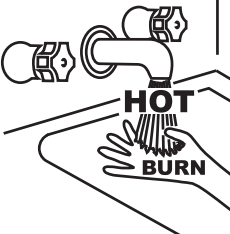

Water temperature over 125°F (52°C) can cause severe burns instantly resulting in severe injury or death.

Children, the elderly and the physically or mentally disabled are at highest risk for scald injury.

Feel water before bathing or showering.

Temperature limiting devices such as thermostatic point-of-use mixing valves must be installed when required by codes and to ensure safe temperatures at fixtures.

**⚠ WARNING**

**Toxic Chemical Hazard**

- Do not connect to non-potable water system.

## THERMOSTATIC POINT-OF-USE MIXING VALVES

Water heated to a temperature which will satisfy clothes washing, dish washing, and other sanitizing needs can scald and cause permanent injury upon contact. Short repeated heating cycles caused by small hot water uses can cause temperatures at the point of use to exceed the water heater's temperature setting by up to 20°F (11°C).

**⚠ DANGER**

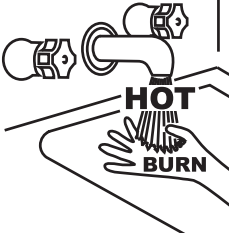

Water temperature over 125°F (52°C) can cause severe burns instantly resulting in severe injury or death.

Children, the elderly and the physically or mentally disabled are at highest risk for scald injury.

Feel water before bathing or showering.

Temperature limiting devices such as thermostatic point-of-use mixing valves must be installed when required by codes and to ensure safe temperatures at fixtures.

Some people are more likely to be permanently injured by hot water than others. These include the elderly, children, the infirm and the physically/mentally disabled. *Table 5* shows the approximate time-to-burn relationship for normal adult skin. If anyone using hot water provided by the water heater being installed fits into one of these groups or if there is a local code or state law requiring a certain water temperature at the point of use, then special precautions must be taken.

**⚠ WARNING**

**Burn Hazard**

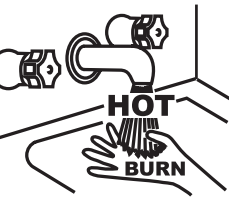

If you choose a higher temperature setting, install thermostatic mixing valves at each point-of-use to help avoid scalding.

*In addition to using the lowest possible temperature setting that satisfies the demand of the application a means, such as a thermostatic point-of-use mixing valve, for example, can be used at the hot water taps used by these people to reduce the water temperature. See Figure 5 (page 16).*

Check State and/or local codes for thermostatic point-of-use mixing valve requirements and installation practices.

Mixing valves are available at plumbing supply stores. Consult a Qualified Installer or Service Agency. Follow mixing valve manufacturer's instructions for installation of the valves.

Table 5. Burn Time at Various Temperatures		
Water Temperature °F (°C)	Time for 1st Degree Burn (Less Severe Burns)	Time for Permanent Burns 2nd & 3rd Degree (Most Severe Burns)
110 (43)	(normal shower temp.)	
116 (47)	(pain threshold)	
116 (47)	35 minutes	45 minutes
122 (50)	1 minute	5 minutes
131 (55)	5 seconds	25 seconds
140 (60)	2 seconds	5 seconds
149 (65)	1 second	2 seconds
154 (68)	instantaneous	1 second

(U.S. Government Memorandum, C.P.S.C., Peter L. Armstrong, Sept. 15, 1978)

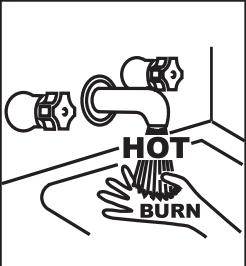
	⚠ <b>WARNING</b>
	<p><b>Burn Hazard</b></p> <p>To reduce the risk of unusually hot water reaching the fixtures in the house, install thermostatic mixing valves at each point of use.</p>

### DISH-WASHING MACHINES

All dish-washing machines meeting the National Sanitation Foundation requirements are designed to operate with water flow pressures between 15 and 25 pounds per square inch (103 kPa and 173 kPa). Flow pressures above 25 pounds per square inch (173 kPa), or below 15 pounds per square inch (103 kPa), will result in improperly sanitized dishes. Where pressures are high, a water pressure reducing or flow regulating control valve should be used in the 180°F (82°C) line to the dish-washing machine and should be adjusted to deliver water pressure between these limits.

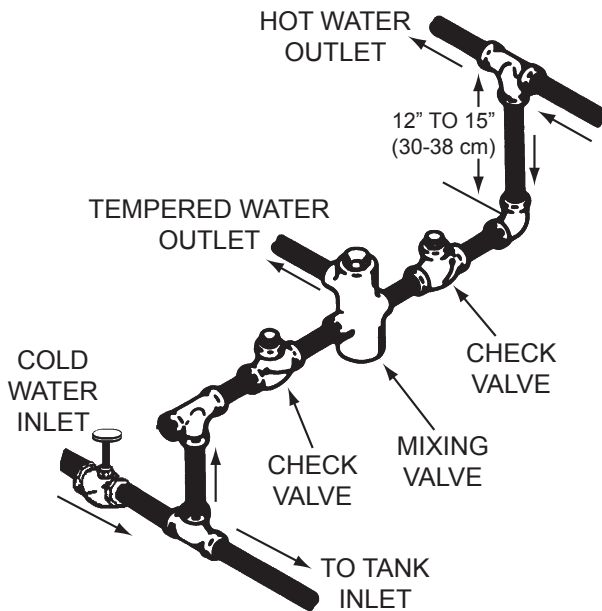

Figure 5. Mixing Valve

The National Sanitation Foundation also recommends circulation of 180°F (82°C) water. The circulation should be just enough to provide 180°F (82°C) water at the point of take-off to the dish-washing machine.

Adjust flow by throttling a full port ball valve installed in the circulating line on the outlet side of the pump. Never throttle flow on the suction side of a pump. See the *Piping Diagram* (page 42).

**Note:** To comply with *NSF Standard 5* installation requirements, the bottom of the water heater must be sealed to the floor with a silicone based sealant or elevate

### CONTAMINATED WATER

This water heater shall not be connected to any heating system(s) or component(s) used with a non-potable water heating appliance.

Toxic chemicals, such as those used for boiler treatment shall not be introduced into this system.

### RECIRCULATING LOOP

The use of a recirculation loop is permitted with a maximum water flow rate of 1.25 gpm. Higher water flow rates will result in reduced water heater efficiency and performance. Keep the water line runs as short as possible to minimize heater operation run time and heat loss.

Refer to the circulating pump manufacturer's instructions for its operation, lubrication, and maintenance instructions.

### HARD WATER

Where hard water conditions exist, water softening or the threshold type of water treatment is recommended. This will protect the dishwashers, coffee urns, water heaters, water piping, and other equipment.

### WATER OUTLET TUBE

There is a tube installed in the water outlet connection of the water heater. Take care not to move or damage it when installing the water piping connections.

### TEMPERATURE-PRESSURE RELIEF VALVE

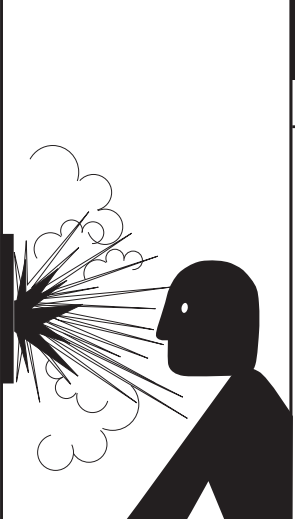
	⚠ <b>WARNING</b>
	<p><b>Explosion Hazard</b></p> <ul style="list-style-type: none"> <li>• Temperature-Pressure Relief Valve must comply with <i>ANSI Z21.22- CSA 4.4</i> and <i>ASME</i> code.</li> <li>• Properly sized temperature-pressure relief valve must be installed in opening provided.</li> <li>• Can result in overheating and excessive tank pressure.</li> <li>• Can cause serious injury or death.</li> </ul>

This water heater is provided with a properly rated/sized and certified combination temperature-pressure relief valve (T&P valve) by the manufacturer. The valve is certified by a nationally-recognized testing laboratory that maintains periodic inspection of the production of listed equipment and of materials as meeting the requirements for *Relief Valves for Hot Water Supply Systems, ANSI Z21.22 • CSA 4.4*, and the code requirements of *ASME*.

If replaced, the new T&P valve must meet the requirements of local codes, but not less than a combination temperature-pressure relief valve rated/sized and certified as indicated in the above paragraph. The new valve must be marked with a maximum set pressure not to exceed the marked hydrostatic working pressure of the water heater (150 psi = 1,035 kPa) and a discharge capacity not less than the water heater Btu/hr or kW input rate, as shown on the water heater's model rating label.

**Note:** In addition to the factory supplied temperature-pressure relief valve on the water heater, each remote-storage tank that is installed and piped to a water heating appliance must also have its own properly-sized, rated, and approved

temperature-pressure relief valve installed. Call the toll-free technical-support phone number listed on the back cover of this manual for technical assistance in sizing a temperature-pressure relief valve for remote storage tanks.

For safe operation of the water heater, the temperature-pressure relief valve must not be removed from its designated opening, nor plugged. The temperature-pressure relief valve must be installed directly into the fitting of the water heater designed for the relief valve. Install discharge piping so that any discharge exits the pipe six inches (15.2 cm) above an adequate floor drain, or external to the building. In cold climates, it is recommended that it be terminated at an adequate drain inside the building. Be certain that no contact is made with any live electrical part. The discharge opening must not be blocked or reduced in size under any circumstances. Excessive length over 30 feet (9.14 m) or use of more than four elbows can cause restriction and reduce the discharge capacity of the valve.

No valve or other obstruction is to be placed between the temperature-pressure relief valve and the tank. Do not connect discharge piping directly to the drain unless an air gap of six inches (15.2 cm) is provided. To prevent bodily injury, hazard to life, or property damage, the relief valve must be allowed to discharge water in adequate quantities if circumstances demand. If the discharge pipe is not connected to a drain or other suitable means, the water flow could cause property damage.

## CAUTION

### Property Damage Hazard

- The temperature-pressure relief-valve discharge pipe must terminate at an adequate drain.

#### T&P Valve Discharge Pipe Requirements:

- Shall not be smaller in size than the outlet-pipe size of the valve, or have any reducing couplings or other restrictions.
- Shall not be plugged or blocked.
- Shall not be exposed to freezing temperatures.
- Shall be of material listed for hot water distribution.
- Shall be installed so as to allow complete drainage of both the temperature-pressure relief valve and the discharge pipe.
- Must terminate a maximum of six inches (15.2 cm) above a floor drain or external to the building. In cold climates, it is recommended that the discharge pipe be terminated at an adequate drain inside the building.
- Shall not have any valve or other obstruction between the relief valve and the drain.

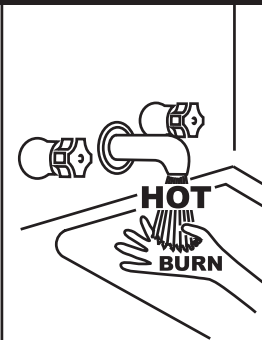
	<p><b>⚠ DANGER</b> Water temperature over 125°F (52°C) can cause severe burns instantly resulting in severe injury or death.</p>
	<p>Children, the elderly and the physically or mentally disabled are at highest risk for scald injury.</p>
	<p>Feel water before bathing or showering.</p> <p>Temperature limiting devices such as thermostatic point-of-use mixing valves must be installed when required by codes and to ensure safe temperatures at fixtures.</p>

The temperature-pressure relief valve must be manually operated at least twice a year. Caution should be taken to ensure that (1) no one is in front of or around the outlet of the temperature-pressure relief valve discharge line, and (2) the water that is manually discharged does not cause any bodily injury or property damage because the water may be extremely hot. If after manually operating the valve, it fails to completely reset and continues to release water, immediately close the cold-water inlet to the water heater, follow the draining instructions in this manual, and replace the temperature-pressure relief valve with a properly rated/sized new one.

**Note:** The purpose of a temperature-pressure relief valve is to prevent excessive temperatures and pressures in the storage tank. The T&P valve is not intended for the constant relief of thermal expansion. A properly-sized thermal-expansion tank must be installed on all closed systems to control thermal expansion.

If you do not understand these instructions or have any questions regarding the temperature-pressure relief valve, call the toll-free number listed on the back cover of this manual for technical assistance.

#### CLOSED WATER SYSTEMS

Water supply systems may, because of code requirements or such conditions as high line pressure, among others, have installed devices such as pressure reducing valves, check valves, and back flow preventers. Devices such as these cause the water system to be a closed system.

#### THERMAL EXPANSION

As water is heated, it expands (thermal expansion). In a closed system the volume of water will grow when it is heated. As the volume of water grows there will be a corresponding increase in water pressure due to thermal expansion. Thermal expansion can cause premature tank failure (leakage). This type of failure is not covered under the limited warranty. Thermal expansion can also cause intermittent temperature-pressure relief valve operation: water discharged from the valve due to excessive pressure build up. This condition is not covered under the limited warranty. The temperature-pressure relief valve is not intended for the constant relief of thermal expansion.

A properly sized thermal expansion tank should be installed on all closed systems to control the harmful effects of thermal expansion. Contact a local plumbing service agency to have a thermal expansion tank installed.



**CONDENSATE DRAIN LINE INSTALLATION**

- Flexible PVC pipe or tubing must be used to connect the condensate drain to a suitable drain.
- Condensate drain lines should be installed in conditioned areas only.
- Do not connect condensate drain lines with other drain or discharge lines into a single (common) pipe or line. Each line (condensate drain line, temperature and relief valve discharge pipe, etc.) should be independently run to an adequate drain.
- Slope the condensate drain lines toward the inside floor drain.
- The condensate drain lines and connections to the drain piping must comply with all local codes.

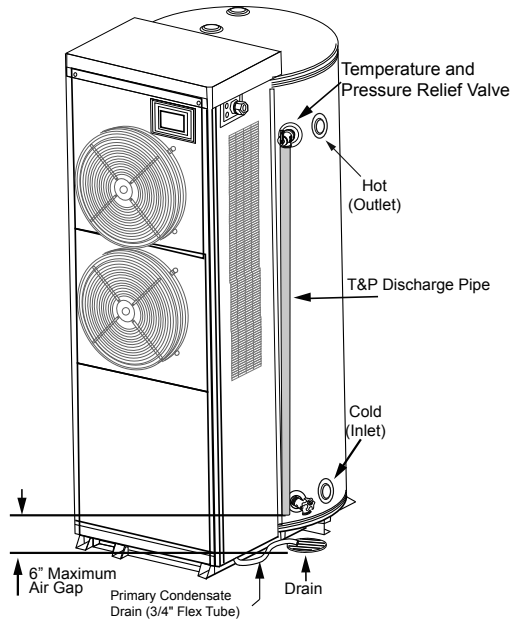

Figure 6. Condensate Tube Installation

**ELECTRICAL**

<b>⚠ WARNING</b>	
	<b>Electrical Shock Hazard</b>
	<ul style="list-style-type: none"> <li>• Before removing any access panels or servicing the water heater, make sure the electrical supply to the water heater is turned OFF.</li> <li>• Failure to follow these instructions can result in personal injury or death.</li> </ul>

The installation must conform with these instructions and the local code authority having jurisdiction and the requirements of the power company. In the absence of local codes, the installation must comply with the current editions of the *National Electrical Code, NFPA 70* or the *Canadian Electrical Code CSA C22.1*.

An electrical ground is required to reduce risk of electrical shock or possible electrocution. The water heater should be connected to a separate grounded branch circuit with over-current protection and disconnect switch. The water heater should be grounded in accordance with national and local codes.

Voltage applied to the heater should not vary more than +5% to -10% of the model and rating plate marking for satisfactory operation.

**DO NOT ENERGIZE THE BRANCH CIRCUIT FOR ANY REASON BEFORE THE HEATER TANK IS FILLED WITH WATER. DOING SO WILL CAUSE THE HEATING**

**ELEMENTS TO BURN OUT AND VOID WARRANTY.**

The factory wiring is attached to a terminal block within the internal control unit. The branch circuit is connected to the terminal block within this control box. The water heater should be connected to a separate, grounded, branch circuit with over-current protection and disconnect switch. The water heater should be grounded in accordance with national and local codes.

**BRANCH CIRCUIT**

The branch circuit wire size should be established through reference to the current edition of *NFPA-70, the National Electrical Code* or other locally approved source in conjunction with the heater amperage rating. For convenience, portions of the wire size tables from the Code are reproduced in **Table 6**. The branch circuit should be sized at 125 percent of the heater rating and further increase wire size as necessary to compensate for voltage drop in long runs.

**CALCULATING AMPERAGE/OVER-CURRENT PROTECTION**

This water heater requires a 208 VAC 80-amp or 240 VAC 90-amp single phase power supply, at 60 Hz.

The rating of the over-current protection should be computed on the basis of 125 percent of the total connected load amperage. Where the standard ratings and settings do not correspond with this computation, the next higher standard rating or setting should be selected.

**Table 6. Allowable Ampacities of Insulated Conductors<sup>1</sup>**

Size	Temperature Rating of Conductor								Size		
	60 °C (140 °F)	75 °C (167 °F)	85 °C (185 °F)	90 °C (194 °F)	60 °C (140 °F)	75 °C (167 °F)	85 °C (185 °F)	90 °C (194 °F)			
AWG MCM	Types RUW, TTW, and UF	Types FEPW, RH, RHW, RUH, THW, THWN, XHHW, USE, and ZW	Types V, and MI	Types TA, TBS, SA, AVB, SJS, FEP <sup>2</sup> , FEPB <sup>2</sup> , RHH <sup>2</sup> , THHN <sup>2</sup> , and XHHW <sup>2,3</sup>	Types RUW, TTW, and UF	Types RH, RHW, RUH, THW, THWN, XHHW, and USE	Types V, and MI	Types TA, TBS, SA, AVB, SJS, RHH <sup>2</sup> , THHN <sup>2</sup> , and XHHW <sup>2,3</sup>	AWG MCM		
<b>Copper</b>					<b>Aluminum or Copper-Clad Aluminum</b>						
18	....	....	....	21	....	....	....	....	....		
16	....	....	22	22	....	....	....	....	....		
14	15	15	25	25	....	....	....	....	....		
12	20	20	30	30	15	15	25	25	12		
10	30	30	40	40	25	25	30	30	10		
8	40	45	50	50	30	40	40	40	8		
6	55	65	70	70	40	50	55	55	6		
4	70	85	90	90	55	65	70	70	4		
3	80	100	105	105	65	75	80	80	3		
2		115	120	120	75	90	95	95	2		
1		130	140	140		100	110	110	1		
0		150	155	155		120	125	125	0		
00		175	185	185		135	145	145	00		
000		200	210	210		155	165	165	000		
0000		230	235	235		180	185	185	0000		
250		255	270	270		205	215	215	250		
300		285	300	300		230	240	240	300		
350		310	325	325		250	260	260	350		
400		335	360	360		270	290	290	400		
500		380	405	405		310	330	330	500		
<b>Ambient Temp °C</b>	<b>Correction Factors</b> For ambient temperatures over 30 °C, multiply the ampacities shown above by the appropriate correction factor to determine the maximum allowable load current.								<b>Ambient Temp °F</b>		
	31-40	.82	.88	.90	.91	.82	.88	.90		.91	86-104
	41-50	.58	.75	.80	.82	.58	.75	.80		.82	105-122
	51-60	.....	.58	.67	.71	.....	.58	.67		.71	123-141
	61-70	.....	.35	.52	.58	.....	.35	.52		.58	142-158
	71-80	.....	.....	.30	.41	.....	.....	.30		.41	159-176
<ol style="list-style-type: none"> <li>Not more than three conductors in raceway, cable, or earth (directly buried), based on ambient temperature of 30°C (86°F)</li> <li>+The load current rating and the over-current protection for these conductors shall not exceed 15 amperes for 14 AWG, 20 amperes for 12 AWG and 30 amperes for 10 AWG copper; or 15 amperes for 12 AWG and 25 amperes for 10 AWG aluminum and copper-clad aluminum.</li> <li>*For dry locations only. See 75°C column for wet locations.</li> </ol>											

**ELECTRICAL CONNECTION INSTRUCTIONS**

If you lack the necessary skills required to properly install the electrical wiring to this water heater, do not proceed but have a qualified electrician perform the installation.

When making the electrical connections, always make sure of the following:

- The electrical service provides either 208 VAC or 240 VAC to the water heater for proper operation.
- Wire sizes and connections comply with all applicable codes or in the absence of local or state codes follow NFPA-70, the National Electrical Code-current edition.
- Wiring enclosed in approved conduit (if required by local codes).
- The water heater and electrical supply are properly grounded.
- The electrical supply has the proper overload fuse or breaker protection.

**Connecting the Water Heater to the Power Supply**

Always reference the wiring diagram located on the water heater for the correct electrical connections and connect the electrical supply to the water heater in accordance with local utility requirements and codes. See also *Wiring Diagrams* (page 40).

## WARNING

**Electrical Shock Hazard**

- Before removing any access panels or servicing the water heater, make sure the electrical supply to the water heater is turned OFF.
- Failure to follow these instructions can result in personal injury or death.

When installing the electrical wiring to the water heater, do the following:

1. Turn off power to the electrical wiring to the water heater at the circuit breaker/fuse box.
2. Although this water heater is equipped with “Dry Fire” protection circuitry, be sure tank is completely filled with water, and all air is purged from the tank before making any electrical connections. See *Draining the Water Heater* (page 21).

3. Access the terminal block:
  - 1) Unlatch the top control panel cover and pick up. See *Figure 1* (page 9) and *Figure 7*.
  - Note:** The top control panel cover is hinged and is not removable.
  - 2) Unscrew the power electrical conduit access port. See *Figure 1* (page 9) and *Figure 7*.
4. Run the main power through the power electrical conduit access port. See *Figure 1* (page 9) and *Figure 7*.

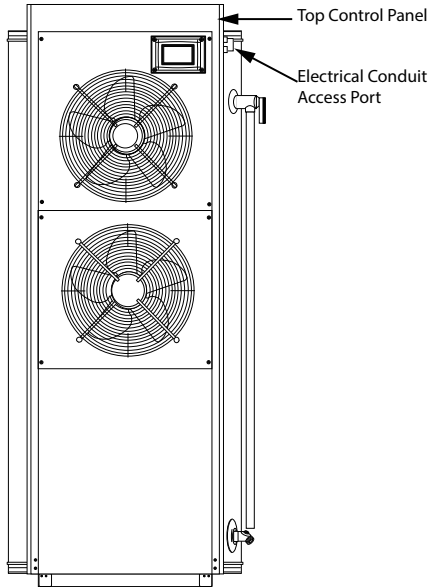

**Figure 7. Electrical Installation**

5. Connect incoming hot wires from the power supply to the terminal block locations marked “L1” and “L2.” See *Figure 8*.
6. Connect the ground wire from the power supply to the terminal marked with the ground symbol. See *Figure 8*.

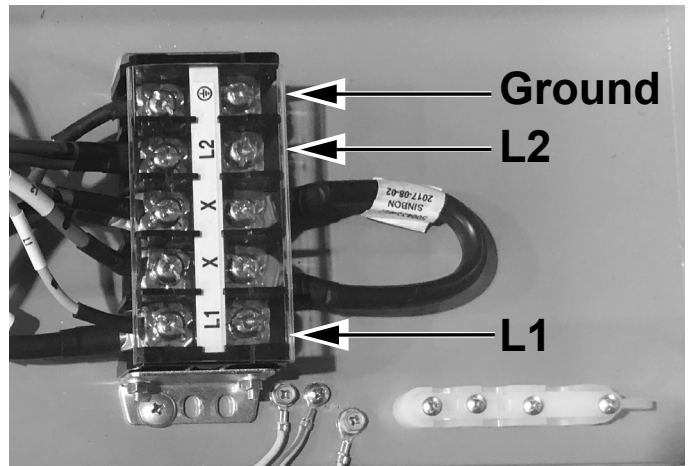

**Figure 8. Terminal Block**

	<p><b>⚠ WARNING</b></p>
	<p><b>Burn Hazard</b></p> <ul style="list-style-type: none"> <li>• Do not connect the water heater to the power supply, unless the tank has been completely filled with water and a T&amp;P valve has been installed.</li> <li>• Water temperature over 125°F (52°C) can cause severe burns instantly or death from scalds. Children, the disabled and elderly are at highest risk of being scalded. Feel water temperature before bathing or showering.</li> </ul>

7. Replace and re-latch the top control panel cover and tighten the Electrical Conduit Access connector.

**Note:** Do not apply power to the water heater before installation is complete and the water heater is filled with water.



# STARTUP

See *Features and Components* (page 9) for the location of components mentioned in the instructions that follow.

NEVER turn on power to the water heater without being certain the water heater is filled with water and a temperature and pressure relief valve is installed in the relief valve opening.

**DO NOT TEST ELECTRICAL SYSTEM BEFORE HEATER IS FILLED WITH WATER. FOLLOW FILLING AND START-UP INSTRUCTIONS IN OPERATION SECTION.**

## FILLING THE WATER HEATER

### CAUTION

#### Property Damage Hazard

To avoid water heater damage, fill tank with water before operating.

1. Turn off the electrical disconnect switch.
2. Close the water heater drain valve.
3. Open a nearby hot water faucet to permit the air in the system to escape.
4. Fully open the cold water inlet pipe valve allowing the heater and piping to be filled.
5. Close the hot water faucet as water starts to flow. The heater is now ready for STARTUP and TEMPERATURE REGULATION.

## INITIAL START UP

The following checks should be made by the installer when the heater is placed into operation for the first time.

1. Turn off the electrical disconnect switch.
2. Check all water and electrical connections for tightness. Also check connections on top and or sides of heater. Repair water leaks and tighten electrical connections as necessary.
3. Depress the red manual reset button on each Thermostat/ECO combination control.
4. Turn on the electrical disconnect switch.
5. Observe the operation of the electrical components during the first heating cycle. Use care as the electrical circuits are energized.

Temperature control and contactor operation should be checked by allowing heater to come up to temperature and shut off automatically. Use care as the electrical circuits are energized.

## DRAINING THE WATER HEATER

The water heater must be drained if it is to be shut down and exposed to freezing temperatures. Maintenance and service procedures may also require draining the heater.

1. Turn off the electrical disconnect switch.
2. Open a hot water valve until the water is cool, then close the supply water inlet valve to heater.
3. Attach hose to outlet opening of drain valve and direct end to drain.
4. Open a nearby hot water faucet and the heater drain valve.

5. If the heater is being drained for an extended shutdown, it is suggested the drain valve be left open during this period. The hose may be removed.

Follow the instructions in *Filling the Water Heater* when restoring hot water service.

	<ul style="list-style-type: none"><li>• Burn hazard.</li><li>• Hot water discharge.</li><li>• Keep hands clear of drain valve discharge.</li></ul>
--	--

## DRY FIRE DETECTION CIRCUIT

The water heaters covered in this manual are equipped with a “Dry Fire Detection” circuit to detect if the water level in the tank is higher than the upper heating element. If the water level in the tank is determined to be lower than the upper heating element the “Dry Fire” fault will be enabled and all water heating will stop.

Whenever electrical power is removed and then restored to the water heater the “Dry Fire Detection” circuit is automatically enabled and lasts approximately 10-12 minutes.

Be sure tank is completely filled with water before applying electrical power to the water heater.

## DEFROST CYCLE

The water heaters covered in this manual are equipped with a defrost cycle to remove frost and/or ice buildup on the evaporator coil. Factors such as air temperature, humidity, air flow, and the condition of the heat pump system influence when and how often the system will enter into a defrost cycle. Noticing steam around the front of the water heater is a normal part of the defrost cycle as it is functioning to melt the frost or ice accumulation on the evaporator coil.

### CAUTION

#### Improper installation, use and service may result in property damage.

- Do not operate water heater if exposed to flooding or water damage.
- Inspect anode rods regularly, replace if damaged.
- Install in location with drainage.
- Fill tank with water before operation.
- Properly sized thermal expansion tanks are required on all closed water systems.

Refer to this manual for installation and service.

# TEMPERATURE REGULATION

## HIGH TEMPERATURE LIMIT CONTROL (ECO)

The water heaters covered by this manual are equipped with both an Electronic Control and Surface Mount Control ECO (energy cut out) non-adjustable high limit control. An ECO is a normally closed switch that opens (activates) on a rise in temperature. If the ECO switch contacts open (activate) due to abnormally high water temperatures it will lock-out and disable further heating element operation. It is important that a qualified service agent be contacted to determine the reason for the ECO activation before resetting the ECO. Once the reason has been determined and corrected the ECO(s) can be reset as follows:

### Electronic Control

The Electronic Control monitors the four tank temperature sensors. The Electronic Control will disable all water heating when any one of the four tank temperature sensors reach approximately 188°F/87°C and will display a fault message. Voltage to the compressor and element contactors is terminated to prevent further heating operation.

If the ECO activates, the water temperature must drop below the water heater's operating setpoint before the control system can be reset. Once the water temperature has cooled below this point the voltage to the compressor and element contactors is restored and the control system will automatically be reset.

### Surface Mount Control

There is a surface-mounted ECO control installed for each installed heating element. The ECO high temperature limit switch contacts on each control will open when the tank temperature reaches approximately 200°F/93°C. When the upper element ECO switch contacts open (activate), voltage to the main control board (CCB) and user interface module (UIM) is terminated to prevent further heating operation. Voltage will still be present to the water heater, however the UIM on the front of the heater will be blank.

When the lower element ECO switch contacts open (activate) voltage to the lower element only is terminated to prevent further heating operation in the bottom of the tank. The upper element will continue to operate to heat water.

The surface-mounted ECO is a manual reset switch. If one or more ECOs activate, the tank temperature must drop below 140°F/60°C and electrical power disconnected and restored before an ECO can be reset. To manually reset an ECO, do the following:

1. Disconnect the power supply to the water heater.
2. Allow the tank temperature to cool below 140°F/60°C.
3. Remove the control cover from the effected control(s).
4. Press the manual reset button on each of the effected controls.

The water heaters covered in this manual are equipped with an Electronic Control system to regulate water temperature inside the storage tank. The control system monitors the temperature from four factory-installed temperature sensors. See *Figure 2* (page 10) for the location of the sensors.

The operating set point is adjusted to regulate water temperature inside the storage tank. This is an adjustable user setting in the control system's Temperatures Menu. This and all control system menus are accessed through the user interface module (UIM) located on the front of the water heater. See *Figure 1* (page 9).

The water heaters covered by this manual have three modes of operation. The Operating Set Point for each mode is adjustable:

- Efficiency Mode: 95°F (35°C) to 150°F (65°C)
- Hybrid Mode: 95°F (35°C) to 150°F (65°C) (Factory Setting)
- Electric Mode: 95°F (35°C) to 180°F (82°C)

The factory setting is 120°F (49°C). See *Operating Set Point Adjustment* (page 27) for instructions on how to adjust the Operation Set Point and other user settings.

Set the Operating Set Point at the lowest setting that produces an acceptable hot water supply. This will always provide the most energy efficient operation.

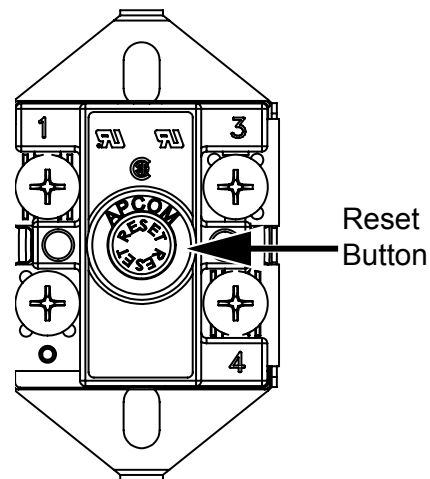

Figure 9. ECO Switch and Reset Button

## THERMOSTAT CONTROL

	<b>⚠ DANGER</b> Water temperature over 125°F (52°C) can cause severe burns instantly resulting in severe injury or death.
	Children, the elderly and the physically or mentally disabled are at highest risk for scald injury.
	Feel water before bathing or showering.
	Temperature limiting devices such as thermostatic point-of-use mixing valves must be installed when required by codes and to ensure safe temperatures at fixtures.

Hot water temperatures required for automatic dishwasher and laundry use can cause scald burns resulting in serious personal injury and/or death. **Table 7** (page 23) shows the approximate time-to-burn relationship for normal adult skin.

The temperature at which injury occurs varies with the person's age and duration of exposure. The slower response time of children, the elderly or disabled persons increases the hazards to them. If anyone using hot water provided by the water heater being installed fits into one of these groups or if there is a local code or state law requiring a certain water temperature at the point of use, then special precautions must be taken.

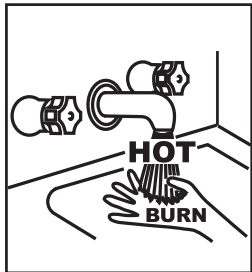

**WARNING**  
**Burn Hazard**  
 If you choose a higher temperature setting, install thermostatic mixing valves at each point-of-use to help avoid scalding.

*In addition to using the lowest possible temperature setting that satisfies the demand of the application, a means, such as a thermostatic point-of-use mixing valve, for example, can be used at the hot water taps used by these people to reduce the water temperature. See Figure 5 (page 16).*

Check State and/or local codes for thermostatic point-of-use mixing valve requirements and installation practices.

Never allow small children to use a hot water tap or draw their own bath water. Never leave a child or disabled person unattended in a bathtub or shower.

The water heater should be located in an area where the general public does not have access to set temperatures.

Setting the Operating Set Point at 120°F (49°C) will reduce the risk of scalds. Some states require settings at specific lower temperatures.

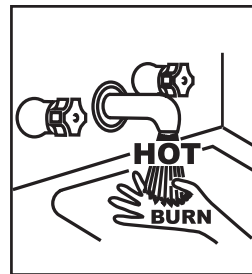

**WARNING**  
**Burn Hazard**  
 To reduce the risk of unusually hot water reaching the fixtures in the house, install thermostatic mixing valves at each point of use.

**Table 7. Burn Time at Various Temperatures**

Water Temperature °F (°C)	Time for 1st Degree Burn (Less Severe Burns)	Time for Permanent Burns 2nd & 3rd Degree (Most Severe Burns)
110 (43)	(normal shower temp.)	
116 (47)	(pain threshold)	
116 (47)	35 minutes	45 minutes
122 (50)	1 minute	5 minutes
131 (55)	5 seconds	25 seconds
140 (60)	2 seconds	5 seconds
149 (65)	1 second	2 seconds
154 (68)	instantaneous	1 second

(U.S. Government Memorandum, C.P.S.C., Peter L. Armstrong, Sept. 15, 1978)

**HIGH TEMPERATURE APPLICATIONS**

Higher operating temperatures cause more wear on all water heaters and will decrease the life span of the water heater. Consider installing a small booster water heater for high temperature applications, such as commercial dishwashers, to raise the outlet temperature from the larger primary water heater to the desired point of use temperature.

Contact your local distributor or contact Technical Support for assistance. See the contact information label on the water heater.

# SYSTEM OPERATION

The water heaters covered in this manual are equipped with an Electronic Control system that regulates water temperature inside the storage tank. Heating cycles are managed by the control system. The ECO (energy cut out), pressure switches, temperature sensors, compressor, contactors, relays, and fans are monitored by the control system.

The main components of the control system are the user interface module (UIM) and the main control board (CCB). The UIM is located on the top front side of the water heater. The main control board (CCB) is mounted on top of the water heater inside a protective enclosure.

## OPERATING MODES

**Hybrid Mode** - This is the default, recommended setting. Combining high energy efficiency with reduced recovery time. This mode uses the heat pump as the primary heating source. The heating elements will heat water if demand exceeds a predetermined level so that the setpoint temperature can be recovered more quickly.

**Efficiency Mode** - Is the most energy efficient mode. This mode uses the heat pump to heat water in the tank. The heating elements are not used unless the ambient operating temperature is below 35°F or above 109°F or if the hot water demand exceeds a predetermined level so that the setpoint temperature can be recovered more quickly. If hot water demands are not met in Efficiency Mode it may be necessary to switch to Hybrid Mode.

**Electric Mode** - The water heater functions as a conventional electric unit, relying totally on the heating elements to heat the water in the tank. This mode may be useful in winter to eliminate the output of cold air from the unit.

## CONTROL SYSTEM NAVIGATION

All operational information and user settings are displayed and accessed from the user interface module (UIM). The UIM houses the control system's LCD Touch Display (liquid crystal display).

### The Desktop Screen

During normal operation the control system will display the "Desktop" screen on the LCD Touch Display which is the default screen. The control system will return to the Desktop screen when there are no active Fault or Alert conditions or when there has been no user input for several minutes.

- Menu titles are displayed in the Title Bar when navigating the control system menus.
- The first temperature shown on the Desktop screen, Tank Temperature, is the temperature of the water inside the water heater's storage tank.
- The second temperature shown on the Desktop screen is the Operating Set Point. The Operating Set Point is the temperature at which the control system will maintain the water inside the storage tank.
- Beneath the Operating Set Point is the "Status" line. The Status line shows the current operational state of the control system in real time, see [Table 9](#) (page 26) for a description of the various operational states.
- The Desktop screen also displays animated "Status Icons" to convey operational information, see [Table 8](#) (page 25) for descriptions of the Status Icons.

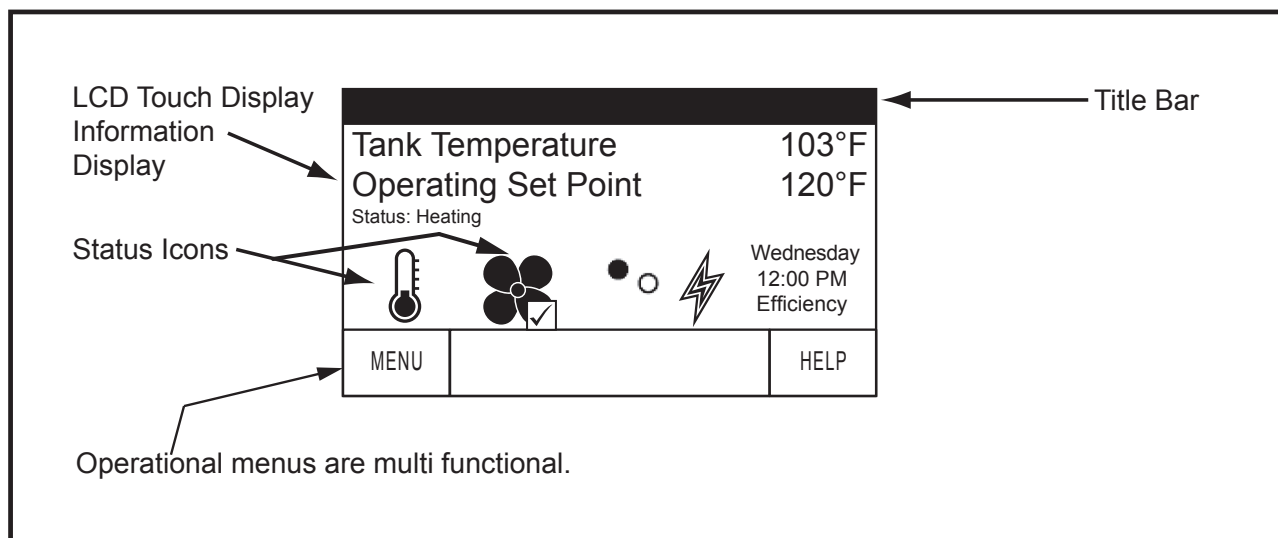









Figure 10. User Interface Module (UIM) Desktop Screen

## Status Icons

The Status Icons are displayed on the Desktop screen and convey operational and diagnostic information. The icons are described in the table below.

Table 8. Status Icons	
Icon	Description
	Water temperature in the tank has fallen. Shaded area of the animated thermometer icon will rise and fall in response to water temperature in the storage tank as sensed from the upper and lower tank temperature sensors.
	Water temperature in the tank has reached the Operating Set Point. The control system enters the Standby mode.
	The control is unable to initiate a heating cycle. This will happen whenever a Fault condition is detected by the control system. The display will read "Status: Water Heating Disabled."
	The control is heating using the heat pump system.
	Heating element status: ● = energized element, ○ = element not energized,
	There is a call for heat and/or the control system is in heating mode.
Wednesday 12:00 PM Efficiency	Day of week, time of day, and current operation mode. "Clock Not Set" is displayed until the time/day is set.
	The control system has declared a Fault condition and must be inspected/serviced by a Qualified Service Agent. Fault message details can be viewed in the Current Fault menu. Heating operation is disabled (lock out) until the condition that caused the Fault is corrected. Power to the water heater must be cycled off and on at the breaker to reset the control system. <b>Note:</b> Some faults are automatically reset by the control system and do not require recycling the power. <b>Note:</b> Cycling power will not reset the control system if the condition that caused the fault has not been corrected.
	The control system has declared an Alert condition and must be inspected/serviced by a Qualified Service Agent. The water heater will continue to operate during an Alert condition.

## OPERATING STATES

The current operational state of the water heater is displayed on the Desktop screen as the “Status.” The common operational states are described in the table below.

State	Description
Standby	The water heater is not in an active heating cycle. IE: the Tank Temperature is at or above the Operating Set Point.
Water Heating Disabled	A Fault condition is detected by the control.
Defrosting	Frost has accumulated on the evaporator and the water heater control is performing a defrosting cycle.
Heating	The control system is in Heating Mode.
Alert	The control system has detected/declared an Alert Condition. The control system will continue heating operation. However, a Qualified Service Agent should be contacted to check/service the water heater.
Fault	The control system has detected a Fault condition. Heating operation is disabled until the Fault condition is corrected. Power to the water heater must be cycled off and on at the breaker to reset the control system. <b>Note:</b> Some Faults are automatically reset by the control system and do not require recycling the power. <b>Note:</b> Cycling power will not reset the control system if the condition that caused the Fault has not been corrected.

## Control System Menus

From the Desktop screen pressing “Menu” on the LCD Touch Display will display the “Main Menu” this is where all control system menus are located. The table below describes the control system menus.

Menu	Description
Temperatures	Most commonly accessed menu. Contains the Operating Set Point, tank temperature, and compressor temperatures.
Mode	Displays and contains the operational modes of the water heater: Efficiency, Electric, and Hybrid.
Heater Status	This menu displays the current state of the elements, fans, and compressor. The on/off status of these heater components are displayed in this menu.
Clock	Contains the Current Time and Current Date user settings.
Display Settings	Temperature units (°F or °C), the LCD appearance (brightness/contrast) and backlight delay user adjustable settings are located in this menu.
Heater Information	Total run time, Modes of Operation run times, Compressor Run Time, Fan Run Time, Element Run Time along with UIM and CCB software revisions can be viewed in this menu.
Current Fault	Displays any current Alert or Fault messages.
Fault History	This control system menu retains a list of the last nine (9) Fault and Alert messages with a time stamp. The newest event will replace the oldest. Faults will clear after 30 days.
Fault Occurrence	This control system menu retains a running total of how many times each Fault condition has occurred since the water heater was first installed. The data does not clear and cannot be reset.
Restore Defaults	This control system feature allows the user to restore control system user settings to their default settings. Display Settings preferences ARE NOT changed when defaults are restored.
Help Screens	Text based operational and user information explaining how to change user settings, navigate the control system menus and icon descriptions.

**USER SETTINGS & CONTROL SYSTEM MENUS**

**Temperatures Menu**

**Operating Set Point Adjustment**

The Operating Set Point is adjustable from 95°F (35°C) to 150°F (65°C) in Efficiency and Hybrid models and 95°F (35°C) to 180°F (82°C) in Electric mode. The factory setting is 120°F (49°C). These user settings are accessed from the Temperatures menu. The following instructions explain how to adjust these settings and navigate the control system menus.

When the water temperature, sensed by the control system from the tank temperature sensors, reaches the Operating Set Point, the control system ends the heating cycle. A heating cycle is activated again when the sensed water temperature drops below the Operating Set Point.

Temperatures Menu	
Description/Action	Display
From the Desktop screen, press MENU. The "Main Menu" screen will be displayed.	<p>Tank Temperature 103°F                  Operating Set Point 120°F                  Status: Heating</p> <p>Tue 07:24 AM                  Efficiency</p> <p>MENU HELP</p>
The Main Menu is where all control system menus are listed, see <i>Table 10</i> (page 26) for a complete list and description of control system menus.  Use the Up and Down slidebar to view all control system menus from the Main Menu.  Press "Temperatures" to access the Temperature menu.	<p>Main Menu</p> <p>Temperatures &gt; ▲                  Mode &gt; ■                  Heater Status &gt; ■                  Clock &gt; ■                  Display Settings &gt; ▼</p> <p>BACK HELP</p>
Press "Operating Setpoint" to access the temperature setpoint menu.  <b>Note:</b> Higher Temperature settings increase wear and operating costs. Set the Operating Set Point to the lowest setting which produces an acceptable hot water supply. This will always provide the most energy efficient operation and longer life.	<p>Temperatures</p> <p>Operating Setpoint 120°F &gt; ▲                  Tank Temperature 81°F ■                  Upper Temperature 82°F ■                  Mid Upper Temperature 82°F ■                  Mid Lower Temperature 79°F ▼                  Lower Temperature 73°F ▼</p> <p>BACK HELP</p>



Temperatures Menu	
Description/Action	Display
<p>Use the "+" and "-" Buttons to change the current setting.</p> <p>Press "ACCEPT" to save the new setting. Press "BACK" to discard changes and return to the previously saved setting.</p> <p><b>Note:</b> Use this procedure to change the adjustable user settings in the control system menus.</p>	<p>The display shows a black header 'Operating Setpoint' with '120°F' below it. Underneath, 'MIN 95°F' and 'MAX 150°F' are shown. To the right are '+' and '-' buttons. At the bottom are 'ACCEPT' and 'BACK' buttons.</p>
<ul style="list-style-type: none"> <li>• <b>Tank Temperature</b> - Non adjustable. Control system sensed temperature (averaged from mid upper &amp; mid-lower temperature sensors).</li> <li>• <b>Upper Temperature</b> - Non adjustable. Control system upper temperature sensor sensed temperature.</li> <li>• <b>Mid-Upper Temperature</b> - Non adjustable. Control system mid-upper temperature sensor sensed temperature.</li> <li>• <b>Mid-Lower Temperature</b> - Non adjustable. Control system mid-lower temperature sensor sensed temperature.</li> <li>• <b>Lower Temperature</b> - Non adjustable. Control system lower temperature sensor sensed temperature.</li> </ul>	<p>The display shows a black header 'Temperatures'. Below it is a list: 'Operating Setpoint 120°F &gt;', 'Tank Temperature 82°F', 'Upper Temperature 82°F', 'Mid Upper Temperature 82°F', 'Mid Lower Temperature 79°F', and 'Lower Temperature 73°F'. To the right of the list are up and down arrow buttons. At the bottom are 'BACK' and 'HELP' buttons.</p>

Mode of Operation Menu	
Description/Action	Display
<p>Press Mode to access the Mode menu.</p>	<p>The display shows a black header 'Main Menu'. Below it are five options: 'Temperatures &gt;', 'Mode &gt;', 'Heater Status &gt;', 'Clock &gt;', and 'Display Settings &gt;'. To the right of the options are up and down arrow buttons. At the bottom are 'BACK' and 'HELP' buttons.</p>
<p>Press &gt; to activate the adjustment mode for this menu item.</p>	<p>The display shows a black header 'Mode'. Below it, 'Mode Hybrid &gt;' is shown. To the right of the text are up and down arrow buttons. At the bottom are 'BACK' and 'HELP' buttons.</p>



Mode of Operation Menu	
Description/Action	Display
<p>Use the “+” and “-” Buttons to change the current setting. There are 3 modes of operation, Efficiency, Hybrid, and Electric. Hybrid mode is the factory setting.</p> <p>Press “ACCEPT” to save the new setting. Press “BACK” to discard changes and return to the previously saved setting.</p> <p><b>Note:</b> Use this procedure to change the adjustable user settings in the control system menus.</p>	

Heater Status Menu	
Description/Action	Display
<p>Press Heater Status from the Main Menu to enter this menu. This menu contains non adjustable operational information. Use the sidebar to navigate the menu.</p> <ul style="list-style-type: none"> <li>• <b>Status</b> - displays the current Operating State. See <i>Table 9</i> (page 26).</li> <li>• <b>Mode</b> - Displays the current heater mode of operation.</li> <li>• <b>Upper/Lower Element, Fan, Compressor</b> - displays whether or not the control system is currently energizing these water heater components: on = energized, off = de-energized.</li> <li>• <b>4 Way Valve Status</b> - Displays the status of the 4 Way Valve.</li> <li>• <b>EEV Steps</b> - displays the pulses or signals sent by the CCB.</li> <li>• <b>Power Voltage</b> - Displays the supply voltage.</li> </ul> <p><b>Note:</b> Menu displays shown are for informational purposes only. The actual heater display will vary dependent upon the operational state of the water heater.</p>	

Clock Menu	
Description/Action	Display
<p>Press Clock Settings from the Main Menu to enter this menu. This menu contains adjustable display options for viewing information on the UIM's LCD screen. Use the Sidebar to navigate the menu.</p> <ul style="list-style-type: none"> <li>• <b>Current Date</b> - Adjustable user setting that is used to set the current date.</li> <li>• <b>Current Time</b> - Adjustable user setting that is used to set the current date.</li> </ul> <p><b>Note:</b> These settings are adjusted in the same way as described in <i>Operating Set Point Adjustment</i> (page 27).</p>	

Display Settings	
Description/Action	Display
<p>Press Display Settings from the Main Menu to enter this menu. This menu contains adjustable display options for viewing information on the UIM's LCD screen. Use the Slidebar to navigate the menu.</p> <ul style="list-style-type: none"> <li>• <b>Temperature Units</b> - Adjustable user setting that changes temperature units display to Celsius °C or Fahrenheit °F.</li> <li>• <b>Backlight Delay</b> - Adjustable user setting that determines how long the UIM's LCD backlight remains illuminated after a key has been pressed. Available settings are; Always Off, 10, 30 or 60 seconds and Always On.</li> </ul> <p><b>Note:</b> These settings are adjusted in the same way as described in <i>Operating Set Point Adjustment</i> (page 27).</p>	<p>The screenshot shows the 'Display Settings' menu with three items: 'Temperature Units' set to '°F', 'Brightness' set to '5', and 'Backlight Delay' set to '30s'. Each item has a right-pointing arrow and a vertical slider bar to its right. At the bottom of the screen are two buttons labeled 'BACK' and 'HELP'.</p>

Heater Information	
Description/Action	Display
<p>Press Heater Information from the Main Menu to enter this menu. This menu contains non adjustable operational information.</p> <ul style="list-style-type: none"> <li>• <b>Total Run Time</b> - Total accumulated time the control system (water heater) has been energized.</li> <li>• <b>Efficiency Mode Run Time</b> - Total accumulated time the control system has been in the Efficiency mode of operation.</li> <li>• <b>Electric Mode Run Time</b> - Total accumulated time the control system has been in the Electric mode of operation.</li> <li>• <b>Hybrid Mode Run Time</b> - Total accumulated time the control system has been in the Hybrid mode of operation.</li> <li>• <b>Compressor Run Time</b> - Total accumulated time the compressor has been energized.</li> <li>• <b>Fan Run time</b> - Total accumulated time the fans have been energized.</li> <li>• <b>Upper Element Run Time</b> - Total accumulated time the upper element has been energized.</li> <li>• <b>Lower Element Run Time</b> - Total accumulated time the lower element has been energized.</li> <li>• <b>CCB Version</b> - Software version for the main control board (CCB).</li> <li>• <b>UIM Version</b> - Software version for the user interface module (UIM). Version shown for reference only.</li> </ul>	<p><b>Top of Menu</b></p> <p>The screenshot shows the 'Heater Information' menu with six items: 'Total Run Time' (22Hr), 'Efficiency Mode Run Time' (3Hr), 'Electric Mode Run Time' (0Hr), 'Hybrid Mode Run Time' (17Hr), 'Compressor Run Time' (11Hr), and 'Fan Run Time' (11Hr). Each item has a right-pointing arrow and a vertical slider bar to its right. At the bottom are 'BACK' and 'HELP' buttons.</p> <p><b>Bottom of Menu</b></p> <p>The screenshot shows the 'Heater Information' menu with four items: 'Upper Element Run Time' (0Hr), 'Lower Element Run Time' (0Hr), 'CCB Version' (1.03), and 'UIM Version' (4.10.00). Each item has a right-pointing arrow and a vertical slider bar to its right. At the bottom are 'BACK' and 'HELP' buttons.</p>

Current Fault	
Description/Action	Display
<p>Press Current Fault from the Main Menu to enter this menu. This menu contains non adjustable operational information. Use the Slidebar to navigate the menu.</p> <p>This menu contains the current Fault or Alert error message. The time the Fault or Alert message occurred appears directly below. A brief description of what causes the particular Fault or Alert condition appears below that. Pressing "ADVANCED" will give more detailed service information and a list of possible causes for the Fault or Alert condition. See <i>Fault and Alert Conditions</i> (page 37) for more detailed information and diagnostic procedures.</p> <p>If there is no Fault or Alert condition active this menu will not contain any information, "(none)" will be shown next to Current Fault in the Main menu.</p>	

Fault History	
Description/Action	Display
<p>Press "Fault History" from the Main Menu to enter this menu. This menu contains non adjustable operational information. Use the Slidebar to navigate the menu.</p> <p>This menu contains a list of the last nine (9) Fault and Alert messages with a time stamp. The newest event will replace the oldest. Faults will clear after 30 days.</p> <p>Press the Fault to view details for each Fault or Alert message stored.</p>	

Fault Occurrence	
Description/Action	Display
<p>Press Fault Occurrence from the Main Menu to enter this menu. This menu contains non adjustable operational information. Use the Slidebar to navigate the menu.</p> <p>This menu contains a running total of how many times each Fault condition has occurred since the water heater was first installed.</p>	

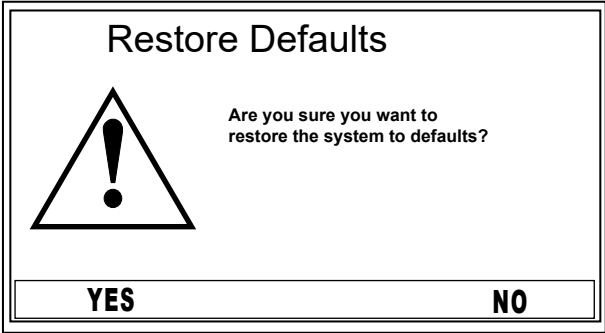
Restore Defaults	
Description/Action	Display
<p>Press Restore Defaults from the Main Menu to enter this menu.</p> <p>To restore the adjustable user settings to their default settings press "YES." The display will show text confirming the default settings have been restored.</p> <p>Press NO to exit the Restore Defaults menu.</p>	 <p>The display shows a confirmation screen titled "Restore Defaults". On the left is a warning icon consisting of a triangle with an exclamation mark inside. To the right of the icon is the text "Are you sure you want to restore the system to defaults?". At the bottom of the screen are two buttons labeled "YES" and "NO".</p>

# MAINTENANCE

**Table 11. Maintenance Schedule**

Component	Operation	Interval	Reference
Tank	Drain and Flush	Every 6 Months	See <i>Draining the Water Heater</i> (page 21) and <i>Flushing the Water Heater Storage Tank</i> (page 33).
Tank	Lime Scale Removal (Water Less Than 25 Grains Hard)	Not Required	N/A
Tank	Lime Scale Removal (Water Greater Than 25 Grains Hard)	Annually	See <i>Sediment Removal</i> (page 34).
Moving Parts	Lubrication	Not Required	N/A
Anodes	Inspection /Cleaning	Annually	See <i>Anode Rod Maintenance</i> .
T&P Valve	Test Operation	Semi Annually	See <i>Temperature-Pressure Relief Valve Test</i> (page 35).

## CAUTION

### Property Damage Hazard

- The temperature-pressure relief-valve discharge pipe must terminate at an adequate drain.

Periodically the drain valve should be opened and the water allowed to run until it flows clean. This will help to prevent sediment buildup in the tank bottom.

Periodically check the temperature and pressure relief valve to ensure that it is in operating condition. Lift the lever at the top of the valve several times until the valve seats properly and operates freely.

Water heater maintenance includes periodic tank flushing and cleaning, and removal of lime scale from the heating element.

### ANODE ROD MAINTENANCE

The heater tank is equipped with an anode rod to aid in corrosion control.

## CAUTION

### Property Damage Hazard

- Avoid damage.
- Inspection and replacement of anode rod required.

The anode rod is used to protect the tank from corrosion. Most hot-water tanks are equipped with an anode rod. The submerged rod sacrifices itself to protect the tank. Instead of corroding the tank, water ions attack and eat away the anode rod. This does not affect water's taste or color. The rod must be maintained to keep the tank in operating condition.

Anode deterioration depends on water conductivity, not necessarily water condition. A corroded or pitted anode rod indicates high water conductivity and should be checked and/or replaced more often than an anode rod that appears to be intact. Replacement of a depleted anode rod can extend the life of your water heater. Inspection should be conducted by a qualified service agency.

Artificially-softened water is exceedingly corrosive because the process substitutes sodium ions for magnesium and calcium ions.

The use of a water softener may decrease life of the water heater tank.

### Anode Rod Inspection

The water heaters covered in this manual are factory equipped with an anode rod mounted in the top of the unit. Anode rods require inspection and cleaning that should be performed once a year.

To inspect the powered anode, do the following:

1. Turn off electrical supply to the water heater.
2. Shut off the water supply and open a nearby hot water faucet to depressurize the water tank.
3. Drain approximately 5 gallons of water from tank. See *Draining the Water Heater* (page 21) for proper procedures. Close drain valve.
4. Remove the plastic cap on top of the water heater tank.
5. Remove the anode by loosening the 3/4" NPT bushing that forms the top of the anode.
6. Remove the entire anode rod from the water heater for inspection.
  - If undamaged and in working order, clean the anode rod with a soft cloth and reinstall.
  - If the anode needs to be replaced, obtain a new anode rod. Apply thread sealer tape or an approved pipe sealant on the threads before installing the new anode rod.

Whether re-installing or replacing the anode rod, check for any leaks and immediately and correct if found.

7. Turn on water supply and open nearby hot water faucet to purge air from water system.
8. Refill the water heater following the instructions for *Filling the Water Heater* (page 21).
9. Restart the water heater as directed in this manual.

**Note:** Artificially-softened water requires that the anode rod to be inspected annually.

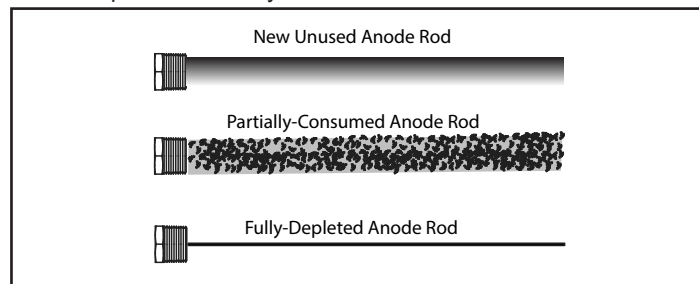

**Figure 11. Anode Rod Depletion**

### Flushing the Water Heater Storage Tank

1. Turn off the electrical supply to the water heater.
2. Ensure the cold water inlet valve is open.
3. Open a nearby hot water faucet and let the water run until the water is no longer hot. Then close the hot water faucet.
4. Connect a hose to the drain valve and terminate it to an adequate drain.
5. Ensure the drain hose is secured before and during the entire flushing procedure. Flushing is performed with system water pressure applied to the water heater.
6. Open the water heater drain valve to flush the storage tank.
7. Flush the water heater storage tank to remove sediment and allow the water to flow until it runs clean.
8. Close the water heater drain valve when flushing is completed.
9. Remove the drain hose.

10. Fill the water heater - see *Filling the Water Heater* (page 21).
11. Turn on the electrical supply to place the water heater back in operation.
12. Allow the water heater to complete several heating cycles to ensure it is operating properly.

### SEDIMENT REMOVAL

Waterborne impurities consist of the particles of soil and sand which settle out and form a layer of sediment on the bottom of the tank.

For convenience, sediment removal and lime scale removal should be performed at the same time.

### Lime Scale Removal

Lime scale accumulations on the heating elements is a normal condition, common to all immersion type elements. Factors which affect the amounts of this formation are:

1. Amount of hot water used. As the volume of water heated increases, more scale results.
2. Water temperature. As the temperature of the water is increased, more scale is deposited on the elements.
3. Characteristics of water supply.
4. Regardless of water treatment, the elements should be examined regularly.

Lime scale accumulations may cause noises to occur during operation.

It is recommended that a heating element be removed periodically for examination. If it is scaled, all of the elements should be removed and cleaned. If the tank bottom has an accumulation of sediment it should be cleaned.

Lime scale should be removed by dissolving the accumulation in UN•LIME® delimer. Do not use muriatic or hydrochloric acid base deliming solutions to remove lime scale from the elements.

### HEATING ELEMENT REPLACEMENT

Replacement heating elements must be of the same style and Voltage/wattage rating as the ones originally in the water heater. This information can be found on the flange or terminal block of the element or on the water heater data plate.

**Important:** Before replacing any element, confirm that you have the correct replacement element (wattage). DO NOT replace the element(s) with a wattage, style or shape different than the elements specified for the upper and/or lower element.

1. Turn off power to the water heater at the breaker disconnect switch serving the water heater.
2. Verify there is no power at the incoming power connection to the water heater with an AC volt meter.
3. Open a nearby hot water faucet and allow to run until the water is no longer hot.
4. Close the cold water shut-off valve to the heater.
5. Drain the water heater by connecting a hose to the drain valve and terminating it to an adequate drain or to the exterior of the building. When unit is drained, close the drain valve and remove hose.

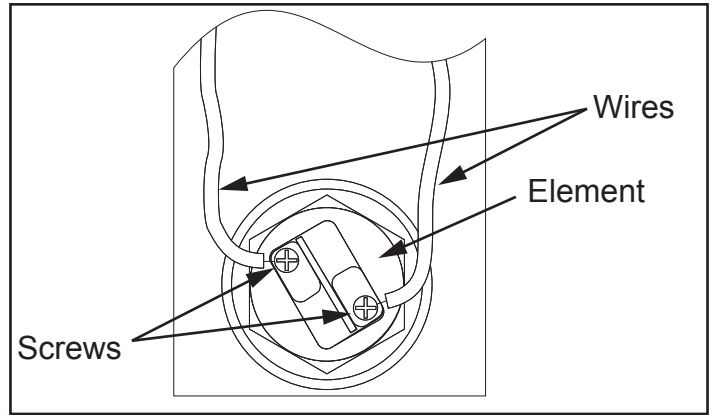

Figure 12. Heating Element Wiring

6. Remove the water heater's left side access panel and the element access cover.
7. Remove the protective plastic cover from the element.
8. Disconnect the electrical wires from the heating element by loosening the screws (Figure 12). Remove the screw-in element by turning the element counterclockwise with a 1-1/2 inch socket wrench. Remove the existing gasket.

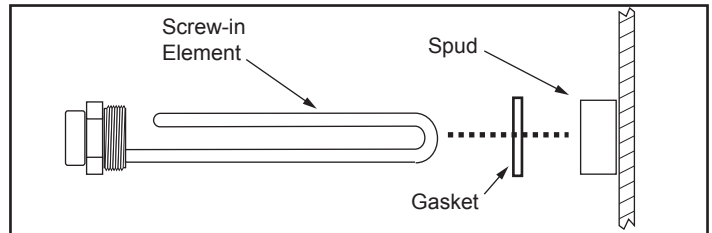

Figure 13. Heating Element Components

<b>⚠ WARNING</b>	
	<b>Electrical Shock Hazard</b>
	<ul style="list-style-type: none"> <li>• Before removing any access panels or servicing the water heater, make sure the electrical supply to the water heater is turned OFF.</li> <li>• Failure to follow these instructions can result in personal injury or death.</li> </ul>

9. Clean the area where the gasket fits to the tank. If you are replacing the bottom element, remove any accumulated sediment on the bottom of the tank.
10. Make sure the replacement element has the correct voltage and wattage rating and shape by matching it to the rating plate on the water heater. Position the new gasket(s) on the element and insert it into the water heater tank (Figure 13). Tighten the element by turning it clockwise until secure.
11. Close the drain valve and open the nearest hot water faucet. Then open the cold water shut off valve and allow the tank to fill completely with water. To purge the lines of any excess air and sediment, keep the hot water faucet open for three (3) minutes after a constant flow of water is obtained.
12. Check for leaks around the element.
13. Reconnect the electrical wires to the element and securely tighten the screws (Figure 12).
14. Replace the protective plastic cover removed earlier. Make sure the covers are securely engaged on the attachment points.
15. Replace the element access cover and water heater panel.

16. Although this water heater is equipped with “Dry Fire” protection circuitry, be sure tank is completely filled with water before applying electrical power to the water heater.

#### TEMPERATURE-PRESSURE RELIEF VALVE TEST

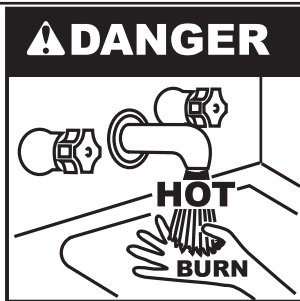
	<ul style="list-style-type: none"> <li>• Burn hazard.</li> <li>• Hot water discharge.</li> <li>• Keep clear of Temperature-Pressure Relief Valve discharge outlet.</li> </ul>
--	---

It is recommended that the Temperature-Pressure Relief Valve should be checked to ensure that it is in operating condition every 6 months.

When checking the Temperature-Pressure Relief Valve operation, make sure that (1) no one is in front of or around the outlet of the Temperature-Pressure Relief Valve discharge line, and (2) that the water discharge will not cause any property damage, as the water may be extremely hot. Use care when operating valve as the valve may be hot.

To check the relief valve, lift the lever at the end of the valve several times. See *Figure 14*. The valve should seat properly and operate freely.

If after manually operating the valve, it fails to completely reset and continues to release water, immediately close the cold water inlet to

the water heater and drain the water heater. See *Draining and Flushing* (page 77). Replace the Temperature-Pressure Relief Valve with a properly rated/sized new one. See *Temperature-Pressure Relief Valve* (page 24) for instructions on replacement.

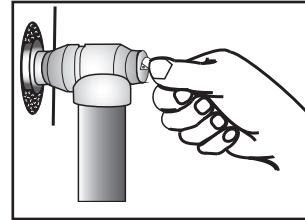

**Figure 14. Testing the T&P Relief Valve**

If the Temperature-Pressure Relief Valve on the water heater weeps or discharges periodically, this may be due to thermal expansion.

**Note:** Excessive water pressure is the most common cause of Temperature-Pressure Relief Valve leakage. Excessive water system pressure is most often caused by “thermal expansion” in a “closed system.” See *Closed Water Systems* (page 17) and *Thermal Expansion* (page 23). The Temperature-Pressure Relief Valve is not intended for the constant relief of thermal expansion.

Temperature-Pressure Relief Valve leakage due to pressure build up in a closed system that does not have a thermal expansion tank installed is not covered under the limited warranty. Thermal expansion tanks must be installed on all closed water systems.

**Do not plug the Temperature-Pressure Relief Valve opening. This can cause property damage, serious injury or death.**



# TROUBLESHOOTING

## CHECKLIST

Before calling for service, check the following points to see if the cause of trouble can be identified and corrected.

Reviewing this checklist may eliminate the need of a service call and quickly restore hot water service. See *Figure 1* (page 9) in this manual to identify and locate water heater components.

<b>⚠ WARNING</b>	
	<b>Electrical Shock Hazard</b>
	<ul style="list-style-type: none"><li>• Before removing any access panels or servicing the water heater, make sure the electrical supply to the water heater is turned OFF.</li><li>• Failure to follow these instructions can result in personal injury or death.</li></ul>

## Not Enough Or No Hot Water

1. Be certain the electrical disconnect switch serving the water heater is in the ON position.
2. Check the fuses.  
The electrical disconnect switch usually contains fuses.
3. If the water was excessively hot, and is now cold, the high limit switch may have activated.
4. See the Temperature Regulation section of this manual for more information on how to reset the ECO high limit controls.
5. The capacity of the heater may have been exceeded by a large demand for hot water.
6. Large demands require a recovery period to restore water temperature.
7. Cooler incoming water temperature will lengthen the time required

to heat water to the desired temperature.

8. Look for hot water leakage.
9. Sediment or pipe scale may be affecting water heater operation.

## Abnormal Sounds

10. Sediment or lime scale accumulations on the elements causes sizzling and hissing noises when the heater is operating.
  - The sounds are normal, however, the tank bottom and elements should be cleaned. See the Maintenance section of this manual.

## Water Leakage is Suspected

11. Check to see if the heater drain valve is tightly closed.
12. If the outlet of the relief valve is leaking it may represent:
  - Excessive water temperature.
  - Faulty relief valve.
  - Excessive water pressure.
13. Excessive water pressure is the most common cause of relief valve leakage. It is often caused by a "closed system". See "Closed Water Systems" and "Thermal Expansion" in the Installation section of this manual for more information.
14. Examine the area around the element for gasket leakage.
  - Tighten the elements or, if necessary, follow the WATER AND LIME SCALE REMOVAL procedure to replace the gaskets.

## If You Cannot Identify Or Correct The Source Of Malfunction

1. Turn the power supply to the water heater off.
2. Close the supply water inlet valve to the heater.
3. Contact Technical Support for further assistance or to locate a qualified service agent in your area. See the contact information label on the water heater.



## FAULT AND ALERT CONDITIONS

### Fault Conditions

When the control system declares a Fault condition it will display a Fault message on the control system's LCD with an exclamation "!" mark. The control system will lock out and disable heating operation until the condition is corrected. The water heater must be serviced by a qualified service agent before operation can be restored. Some faults will reset automatically when the fault condition is corrected. Others will require the power supply to be turned off at the breaker or disconnect switch then turned back on.



### Alert Conditions

When the control system declares an Alert condition it will display an Alert message on the control system's LCD with a question "?" mark. The water heater will continue to operate during an Alert condition but the water heater must be serviced by a qualified service agent as soon as possible.

### Resetting Control System Lock Outs

To reset the control system from a lock out condition; turn the power supply off at the breaker or disconnect switch for approximately 20 seconds and then back on. Keep in mind; if the condition that caused the Fault has not been corrected, the control system will continue to lock out.

### Diagnostic Checks

 <b>WARNING</b>	
	<b>Electrical Shock Hazard</b>
	<ul style="list-style-type: none"> <li>• Turn off power at the branch circuit breaker serving the water heater before performing any service.</li> <li>• Label all wires prior to disconnecting when performing service. Wiring errors can cause improper and dangerous operation.</li> <li>• Verify proper operation after servicing.</li> <li>• Failure to follow these instructions can result in personal injury or death.</li> </ul>



The following section, **Fault and Alert Messages** (page 38), lists some of the messages the control system will display on the LCD when there are operational problems. This is not a complete list. Along with each of the Fault and Alert messages described there will be a list of possible causes and things to check and repair.

Only qualified service agents, as defined in **Approvals** (page 3), using appropriate test equipment, should perform any service procedures on the water heater.

**Note:** If you are not qualified and licensed or certified as required by the authority having jurisdiction to perform a given task do not attempt to perform any of the diagnostic or service procedures described in the following section.

If you do not understand the instructions in the following section do not attempt to perform any procedures.

Call the technical support phone number listed on the back cover of this manual for further technical assistance or to locate a qualified service agent in your area.

 <b>WARNING</b>	
<b>Jumping out control circuits or components can result in property damage, personal injury or death.</b>	
<ul style="list-style-type: none"> <li>• Service should only be performed by a qualified service technician using proper test equipment.</li> <li>• Altering the water heater controls and/or wiring in any way could result in permanent damage to the controls or water heater and is not covered under the limited warranty.</li> </ul>	
	<p>Any bypass or alteration of the water heater controls and/or wiring will result in voiding the appliance warranty.</p>
	

**Fault and Alert Messages**

Call the technical support phone number listed on the water heater for further technical assistance or to locate a qualified service agent in your area.

<b>Table 12. Diagnostic Codes</b>			
<b>Display Shows</b>	<b>Error Code</b>	<b>Indicates</b>	<b>Corrective Action</b>
Relay Error	786	Water temperature is sensed to be rising when there is no water heating	Recycle electrical power to heater. Replace main control board.
Top Upper Sensor Fault	787	Upper tank temperature sensor is not functioning.	Replace upper tank temperature sensor.
Mid-Upper Sensor Fault	788	Mid-upper tank temperature sensor is not functioning.	Replace mid-upper tank temperature sensor.
Mid-Lower Sensor Fault	789	Mid-lower tank temperature sensor is not functioning.	Replace mid-lower tank temperature sensor.
Bottom Lower Sensor Fault	78A	Lower tank temperature sensor is not functioning.	Replace lower tank temperature sensor.
System Low Voltage Fault	78B	Power supply voltage is too low.	Check the power supply to the unit and make sure it is higher than 198 VAC.
System High Voltage Fault	78C	Power supply voltage is too high.	Check the power supply to the unit and make sure it is lower than 252 VAC.
Dry Fire Fault	78D	Not enough water in tank.	Fill unit completely with water. Open a nearby hot water faucet to permit air in the system to escape. Close the hot water faucet when water starts to flow without air interruptions.
Discharge Over Temperature Fault	78E	Heat pump discharge temperature is too high.	Contact a qualified installer or service agency for repair. Refer to phone number listed on the technical support label located on the unit.
Discharge Sensor Fault	78F	Heat pump discharge temperature sensor is not functioning.	Contact a qualified installer or service agency for repair. Refer to phone number listed on the technical support label located on the unit.
Coil Sensor Fault	790	Coil temperature sensor is not functioning.	Contact a qualified installer or service agency for repair. Refer to phone number listed on the technical support label located on the unit.
Ambient Sensor Fault	791	Ambient temperature sensor is not functioning.	Contact a qualified installer or service agency for repair. Refer to phone number listed on the technical support label located on the unit.
Suction Sensor Fault	792	Heat pump suction sensor is not functioning.	Contact a qualified installer or service agency for repair. Refer to phone number listed on the technical support label located on the unit.
Low Pressure Fault	793	Heat pump low pressure switch is open.	Contact a qualified installer or service agency for repair. Refer to phone number listed on the technical support label located on the unit.
Communication Error	NA	No communication between main control board and UIM.	Contact a qualified installer or service agency for repair. Refer to phone number listed on the technical support label located on the unit.
Upper Contactor Connection Fault	794	No communication between the main control board and upper element contactor and or elements.	<ol style="list-style-type: none"> <li>1. Turn off power at the breaker or disconnect switch and check for loose connections at the contactors, main board, and elements. If error persists proceed to next step.</li> <li>2. Replace contactor.</li> <li>3. Replace main control board.</li> </ol>
Power Frequency Fault	0C1	Power supply frequency (Hz) is too high or too low.	Check the power supply to the unit and make sure the line frequency is between 56 Hz to 64 Hz.
EEPROM Fault	795	EEPROM Failure	Contact a qualified installer or service agency for repair. Refer to phone number listed on the technical support label located on the unit.
The diagnostic codes listed above are the most common. If a diagnostic code not listed above is displayed, call the telephone number listed on the Technical Support label located on the water heater.			

Table 13. Troubleshooting Chart		
Problem	Possible Cause(s)	Corrective Action
NO HOT WATER	<ol style="list-style-type: none"> <li>No power to the water heater (No lights on the unit are on).</li> <li>ECO open</li> <li>Hot water usage pattern exceeds the capability of the water heater in current mode</li> <li>Non-functioning temperature sensor</li> <li>Faulty thermostatic mixing valve.</li> <li>Leak in plumbing system</li> </ol>	<ol style="list-style-type: none"> <li>Check for blown fuse or tripped breaker. Restore power to unit.</li> <li>Reset the high temperature limit switch; see <i>High Temperature Limit Control (ECO)</i> (page 22) for more information.</li> <li>Change to different mode or modify usage patterns.</li> <li>Contact a qualified person for service.</li> <li>Check hot water at other faucets.</li> <li>Check hot water side of home's plumbing system for leaks.</li> </ol>
INSUFFICIENT HOT WATER/ SLOW HOT WATER RECOVERY	<ol style="list-style-type: none"> <li>Temperature set-point too low</li> <li>Hot water usage pattern exceeds the capability of the water heater in current mode</li> <li>Water connections to unit reversed</li> <li>Heat lost through long run of exposed pipe</li> <li>Hot water leak at faucet or piping</li> <li>Non-functioning heating element</li> <li>Sediment or scale build up in tank</li> <li>Thermostatic mixing valve faulty/set too low.</li> <li>Low supply voltage.</li> <li>Insufficient air flow.</li> <li>Installation space too small.</li> </ol>	<ol style="list-style-type: none"> <li>Increase set point temperature; see <i>Operating Set Point Adjustment</i> (page 27).</li> <li>Change to different mode or modify usage patterns (For example if in Efficiency Mode, switch to Hybrid Mode).</li> <li>Ensure the cold connection is at the bottom and that the hot connection is at the top</li> <li>Insulate exposed piping</li> <li>Repair hot water leaks</li> <li>Call qualified person for service</li> <li>Drain and flush tank. Water conditioning may be necessary to minimize build up.</li> <li>Check hot water at other faucets.</li> <li>Check power (voltage).</li> </ol>
TEMPERATURE TOO HIGH	<ol style="list-style-type: none"> <li>Non Functioning ECO switch.</li> <li>Non functioning thermostat.</li> <li>Grounded/shorted heating element.</li> <li>Thermostatic mixing valve faulty.</li> </ol>	<ol style="list-style-type: none"> <li>Replace ECO switch.</li> <li>Replace tank temperature sensors.</li> <li>Replace heating element.</li> <li>Check hot water at other faucets.</li> </ol>
LOW WATER PRESSURE	Partially closed supply valve	Open supply valve completely.
WATER ODOR	<ol style="list-style-type: none"> <li>A concentration of sulfate in the supply water</li> <li>Little or no dissolved oxygen in the water.</li> <li>A sulfate reducing bacteria which has accumulated within the water heater (this harmless bacteria is nontoxic to humans).</li> <li>An excess of active hydrogen in the tank. This is caused by the corrosion protective action of the anode.</li> </ol>	Replace anode.
SOUNDS	<ol style="list-style-type: none"> <li>Normal expansion and contraction of metal parts during periods of heat-up and cool-down.</li> <li>Sediment buildup on or around the elements.</li> <li>The heat pump compressor or fan running.</li> </ol>	<ol style="list-style-type: none"> <li>No action required.</li> <li>Drain and flush the tank as directed. See the Draining and Flushing section.</li> <li>No action required.</li> </ol>
DRIP FROM TEMPERATURE & PRESSURE RELIEF VALVE	<ol style="list-style-type: none"> <li>Excessive water pressure</li> <li>Add or service a thermal expansion tank.</li> <li>Non-functioning Temperature &amp; Pressure Relief Valve</li> <li>Debris under valve seat.</li> </ol>	<ol style="list-style-type: none"> <li>Check water supply inlet pressure. If higher than 80 PSIG, install a pressure reducing valve. (A 50-60 PSIG valve is recommended.)</li> <li>See <i>Thermal Expansion</i> (page 17).</li> <li>Replace the temperature &amp; pressure relief valve.</li> <li>See the <i>Water Leakage is Suspected</i> (page 36).</li> </ol>

# DIAGRAMS

## WIRING DIAGRAMS

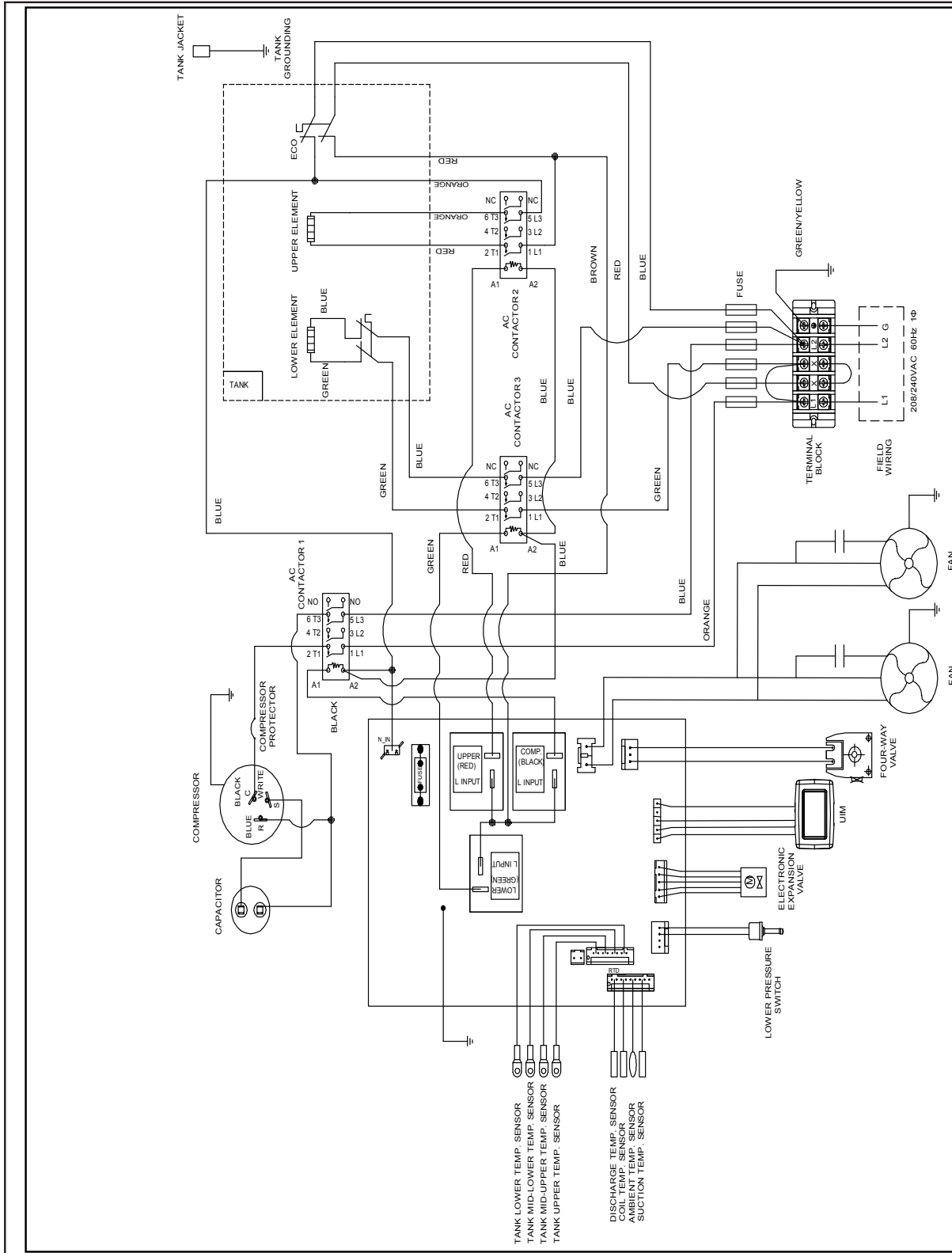

Figure 15. Wiring Diagram

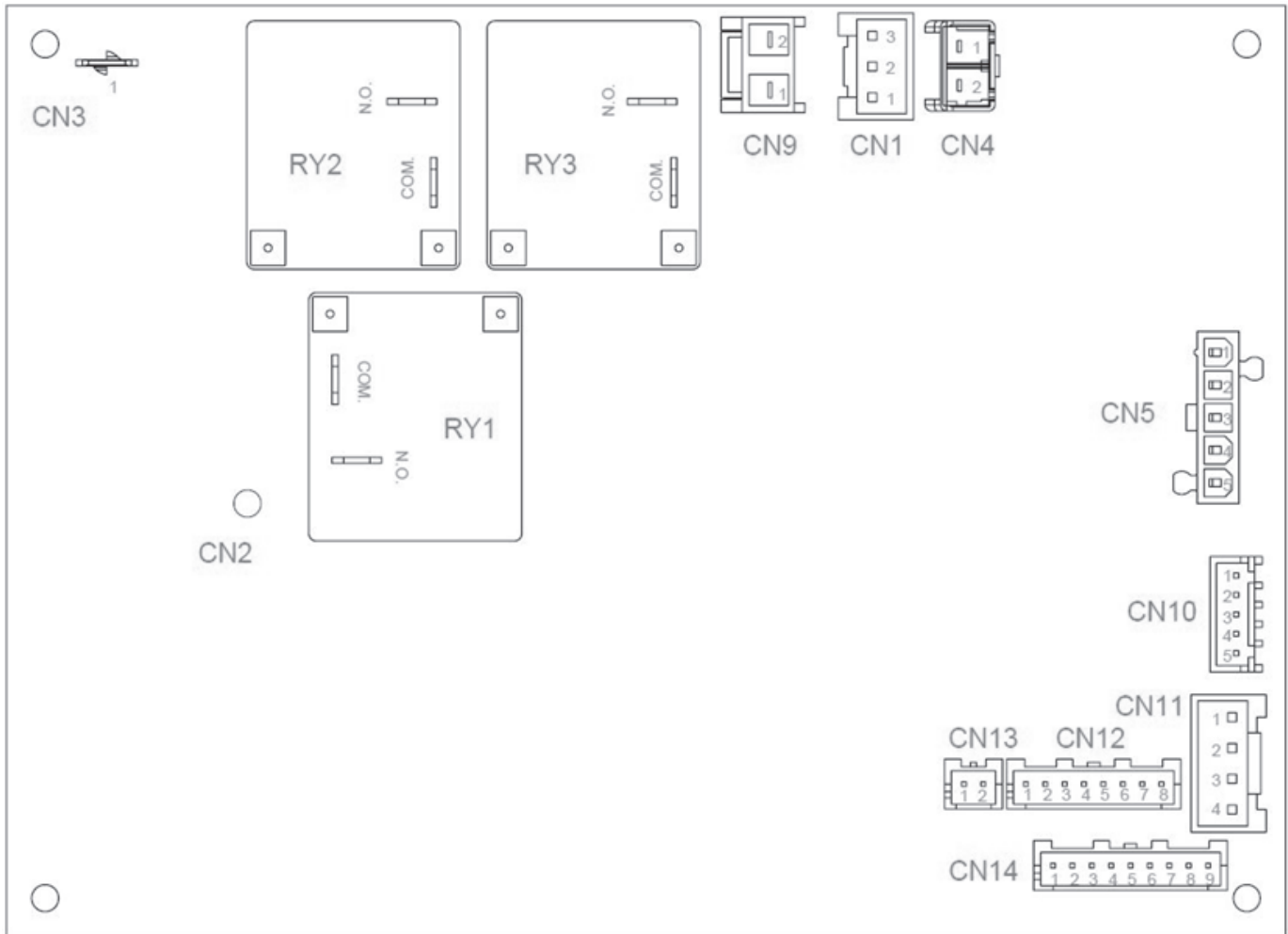

Figure 16. Main Control Board (CCB) Layout

#### MAIN CONTROL BOARD (CCB) CONNECTION IDENTIFICATION

CN1 - Four Way Valve Switch

CN2 - Main Control Board (CCB) Ground

CN3 – Main Control Board (CCB) Power In

CN4 – Not Used

CN5 – UIM Communication Interface

CN9 – Fan Switch

CN10 – Electronic Expansion Valve (EEV)

CN11 – Low Pressure Switch

CN12 – Tank Temperature Sensors

CN13 - Not Used

CN14 – Discharge, Coil, Ambient, and Suction Temperature Sensors

RY1 – Lower Element Relay

RY2 – Upper Element Relay

RY3 – Compressor Relay

**PIPING DIAGRAM**

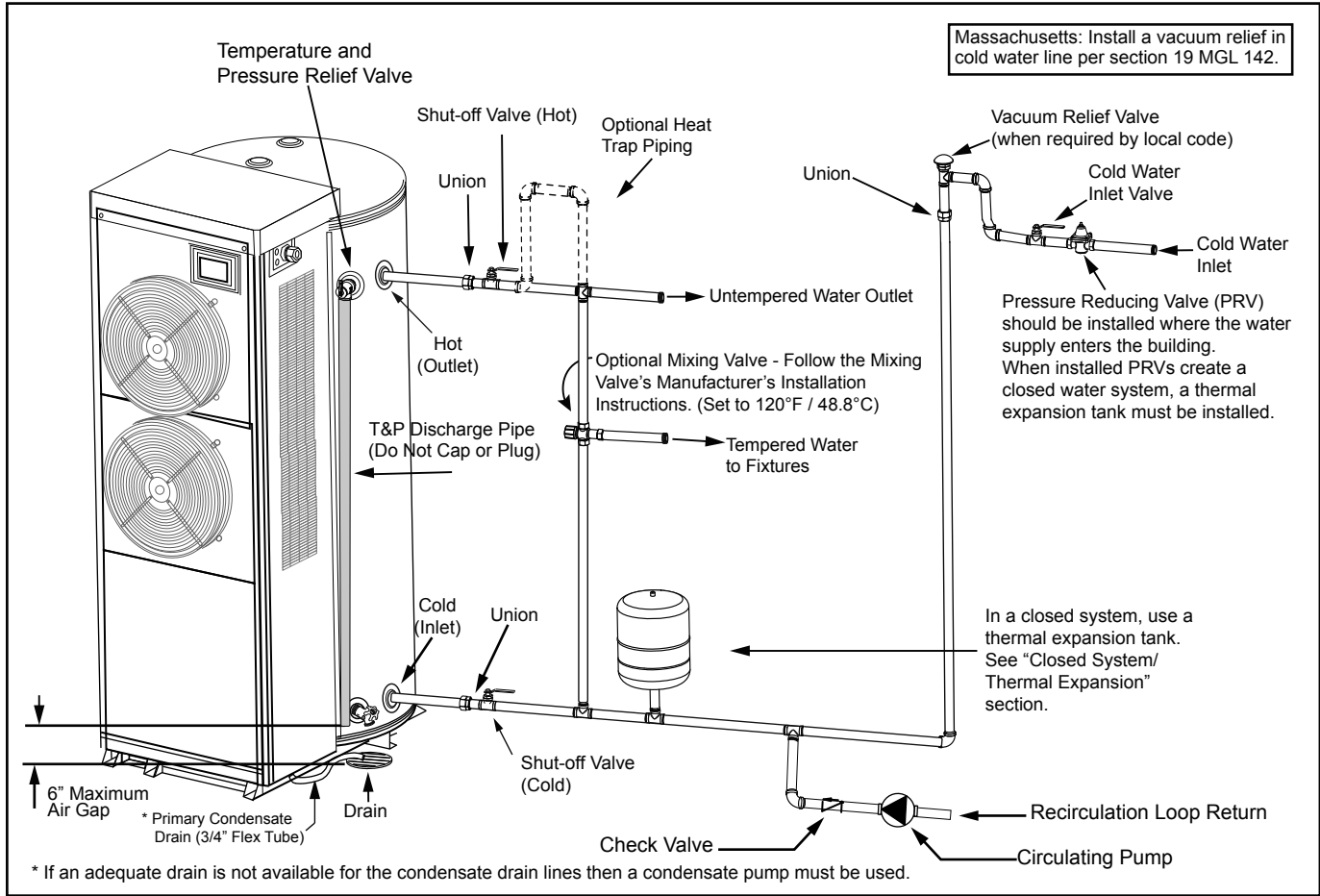

**Figure 17. Completed Water System Piping**

## NOTES

---



