

# MODELS COF-199 THRU 700A

COMMERCIAL OIL FIRED WATER HEATER FOR HOT WATER SUPPLY

• Installation • Service • Maintenance



## **CAUTION**

TEXT PRINTED OR OUTLINED IN RED CONTAINS INFORMATION RELATIVE TO YOUR SAFETY. PLEASE READ THOROUGHLY BEFORE USING APPLIANCE.

**DANGER:** If the information in these instructions is not followed exactly, a fire or explosion may result causing property damage, personal injury or death.

- Do not store or use gasoline or other flammable vapors and liquids in the vicinity of this or any other appliance.
- WHAT TO DO IF YOU SMELL GAS
  - Do not try to light any appliance.
  - Do not touch any electrical switch; do not use any phone in your building.
  - Immediately call your gas supplier from a neighbor's phone. Follow the gas supplier's instructions.
  - If you cannot reach your gas supplier, call the fire department.
- Installation and service must be performed by a qualified installer, service agency or the gas supplier.



# AOSmith®

500 Tennessee Waltz Parkway  
Ashland City, TN 37015  
www.hotwater.com

PLACE THESE INSTRUCTIONS ADJACENT TO HEATER AND  
NOTIFY OWNER TO KEEP FOR FUTURE REFERENCE.

# FEATURES AND SPECIFICATIONS

TEXT PRINTED OR OUTLINED IN RED CONTAINS INFORMATION RELATIVE TO YOUR SAFETY. PLEASE READ THOROUGHLY BEFORE USING APPLIANCE.

applications. The principal components of the heater are shown and identified here. The identification plate illustrations on page 4 interpret certain markings into useful information. Use these references to identify the heater and its components

This is a typical Duraclad oil-fired heater for commercial water heating

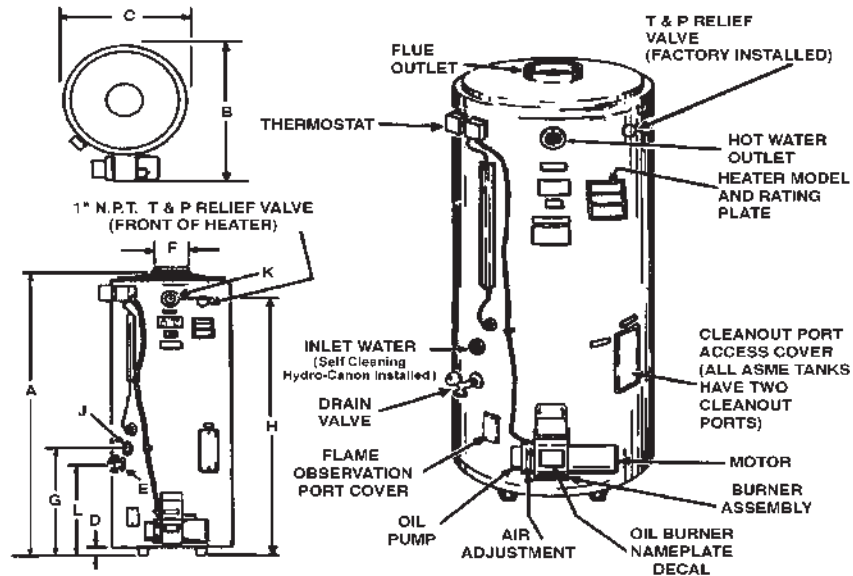

FIGURE 1

TABLE 1 NOMINAL MODEL DIMENSIONS

Model Dim.	COF - 199		COF - 245		COF - 315/315A		COF - 385/385A		COF - 455/455A		COF - 700/700A	
	Inches	mm	Inches	mm	Inches	mm	Inches	mm	Inches	mm	Inches	mm
A	74 1/2	1,892	74 1/2	1,892	74 1/2	1,892	73 3/4	1,873	73 3/4	1,873	73 3/4	1,873
B	36 3/4	933	36 3/4	933	36 3/4	933	36 3/4	933	36 3/4	933	36 3/4	933
C	27 3/4	705	27 3/4	705	27 3/4	705	27 3/4	705	27 3/4	705	27 3/4	705
D	2	51	2	51	2	51	2	51	2	51	2	51
E	3/4 NPT		3/4 NPT		3/4 NPT		3/4 NPT		3/4 NPT		3/4 NPT	
F	8	203	8	203	8	203	8	203	8	203	10	254
G	26 5/8	676	26 5/8	676	26 5/8	676	24 3/4	629	24 3/4	629	30 3/16	767
H	74 1/2	1,892	74 1/2	1,892	74 1/2	1,892	73 3/4	1,873	73 3/4	1,873	79 3/16	2,011
J	1 1/2 NPT		1 1/2 NPT		1 1/2 NPT		1 1/2 NPT		1 1/2 NPT		1 1/2 NPT	
K	1 1/2 NPT		1 1/2 NPT		1 1/2 NPT		1 1/2 NPT		1 1/2 NPT		1 1/2 NPT	
L	22 3/4	578	22 3/4	578	22 3/4	578	23 7/16	595	23 7/16	595	28 7/8	733
Approx. Shipping Weight STD.	553 Lbs	251 Kg.	554 Lbs.	252 Kg.	554 Lbs.	252 Kg.	624 Lbs.	283 Kg.	700 Lbs.	318 Kg.	739 Lbs.	335 Kg.
Approx. Shipping Weight ASME	---	---	---	---	657 Lbs.	298 Kg.	742 Lbs.	337 Kg.	747 Lbs.	339 Kg.	822 Lbs.	373 Kg.

ALL DIMENSIONS IN INCHES/mm

\*Model numbers followed by the suffix "A" indicates the optional A.S.M.E. tank construction.

TABLE 2 RECOVERY CAPACITIES, based on 80% thermal efficiency

Model	TANK CAPACITY		APPROX. EFF.	U.S. Gallons/Hr. and Litres/Hr at TEMPERATURE RISE INDICATED													
				F°	40F°		50F°	60F°	70F°	80F°	90F°	100F°	110F°	120F°	130F°	140F°	
					C°	22.2C°	27.7C°	33.3C°	38.8C°	44.4C°	50C°	55.5C°	61.1C°	66.6C°	72.2C°	77.7C°	
COF 199	199,000	86	80	GPH	477	381	318	272	238	212	191	173	159	147	136		
	58	326	LPH	1804	1443	1203	1031	902	802	722	656	601	555	516			
COF 245	245,000	86	80	GPH	587	469	391	335	293	261	235	213	196	181	168		
	72	326	LPH	2221	1777	1481	1269	1111	987	889	808	740	683	635			
COF 315,000	315,000	84	80	GPH	754	604	503	431	377	335	302	274	251	232	216		
	92	318	LPH	2856	2285	1904	1632	1428	1269	1142	1039	952	879	816			
COF 385,000	385,000	75	80	GPH	922	738	615	527	461	410	369	335	307	284	263		
	113	284	LPH	3491	2793	2327	1995	1745	1551	1396	1269	1164	1074	997			
COF 455,000	455,000	75	80	GPH	1090	872	727	623	545	484	436	396	363	335	311		
	133	284	LPH	4125	3300	2750	2357	2063	1833	1650	1500	1375	1269	1179			
COF 700,000	700,000	69	80	GPH	1677	1341	1118	958	838	745	671	610	559	516	479		
	205	261	LPH	6347	5077	4231	3627	3173	2821	2539	2308	2116	1953	1813			

\* All tanks are tested at 320 psig working pressure.

\*\* Based on No. 2 fuel oil with a heat content of 140,000 Btu's per gallon at 80% thermal efficiency. Above 2,000 altitude, input ratings should be reduced 4% for each 1000' above sea level.

# TABLE OF CONTENTS

<p>FEATURES AND SPECIFICATIONS ..... 2</p> <p>APPROVALS ..... 3</p> <p>IDENTIFICATION</p> <p style="padding-left: 20px;">Oil and Burner Nameplate Decal ..... 3</p> <p style="padding-left: 20px;">Oil Burner Specifications ..... 4</p> <p>SAFETY ..... 4</p> <p>INSTALLATION</p> <p style="padding-left: 20px;">Required Ability ..... 4</p> <p style="padding-left: 20px;">General ..... 4</p> <p style="padding-left: 20px;">Uncrating ..... 4</p> <p style="padding-left: 20px;">Leveling ..... 4</p> <p style="padding-left: 20px;">Location ..... 4-5</p> <p style="padding-left: 20px;">Clearances ..... 5</p> <p style="padding-left: 20px;">Combustion and Ventilation Air ..... 5</p> <p style="padding-left: 20px;">Chemical Vapor Corrosion ..... 5-6</p> <p style="padding-left: 20px;">Flue Gas Venting ..... 6</p> <p style="padding-left: 20px;">Vent Connector and Draft Regulator ..... 6</p> <p style="padding-left: 20px;">Water Piping ..... 7</p> <p style="padding-left: 20px;">Closed Water System ..... 7</p> <p style="padding-left: 20px;">Drain Valve and Access Panels ..... 7</p> <p style="padding-left: 20px;">Fuel Systems ..... 7-8</p> <p style="padding-left: 20px;">Burner Installation ..... 8-9</p> <p style="padding-left: 20px;">Fuel Pump ..... 9</p> <p style="padding-left: 20px;">Wiring Diagrams ..... 10</p> <p>OPERATION</p> <p style="padding-left: 20px;">General ..... 11</p> <p style="padding-left: 20px;">Filling ..... 11</p> <p style="padding-left: 20px;">Start Up ..... 11</p>	<p>Water Temperature Control ..... 11</p> <p>High Limit Switch E.C.O. .... 11-12</p> <p>Burner Certificate (Combustion Test) ..... 12</p> <p>Self-Cleaning Eliminator ..... 12</p> <p>Draining ..... 12</p> <p>MAINTENANCE</p> <p style="padding-left: 20px;">General ..... 12</p> <p style="padding-left: 20px;">Relief Valves ..... 12</p> <p style="padding-left: 20px;">Flushing ..... 13</p> <p style="padding-left: 20px;">Sediment Removal ..... 13</p> <p style="padding-left: 20px;">Lime Scale Removal ..... 13-14</p> <p style="padding-left: 20px;">Circulating Pump ..... 14</p> <p style="padding-left: 20px;">Soot Removal ..... 14</p> <p style="padding-left: 20px;">Vent System ..... 14</p> <p>INSTALLATION DIAGRAMS ..... 15-19</p> <p>CHECKLIST AND SERVICE INFORMATION</p> <p style="padding-left: 20px;">Electrical Wiring Replacement ..... 20</p> <p style="padding-left: 20px;">Not Enough or No Hot Water ..... 20-21</p> <p style="padding-left: 20px;">Burner Starts - Won't Operate ..... 21</p> <p style="padding-left: 20px;">Water Too Hot ..... 21</p> <p style="padding-left: 20px;">Water Heater Makes Sounds ..... 21</p> <p style="padding-left: 20px;">Water Leakage is Suspected ..... 21</p> <p style="padding-left: 20px;">Burner Won't Start ..... 21</p> <p style="padding-left: 20px;">Burner Starts But Fails To Run ..... 21</p> <p style="padding-left: 20px;">Normal Start, But Locks Out On Safety ..... 22</p> <p style="padding-left: 20px;">Safety Primary Control ..... 22</p> <p>COMBUSTION TEST SPECIFICATIONS ..... 22</p> <p>TROUBLESHOOTING ..... 23</p> <p>WARRANTY ..... 24</p>
--	--

## APPROVALS

The burner and controls are listed by Underwriters' Laboratories Inc. Accordingly, the burner bears one of the UL labels indicating periodic inspection of the production of this equipment.

All ASME tanks are built to the standards of Section IV of the American Society of Mechanical Engineers code and are stamped with their symbol. The National Board of Boiler and Pressure Vessel Inspectors papers are furnished upon request. The NB number and HLW symbol (to the right) are on the plate located just below cleanout on tank. (May be viewed by removing cleanout cover on jacket).

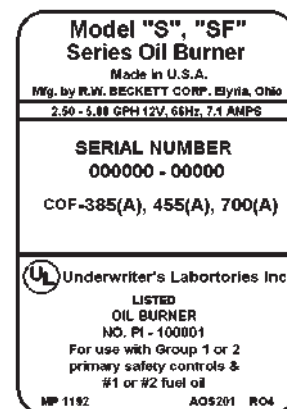
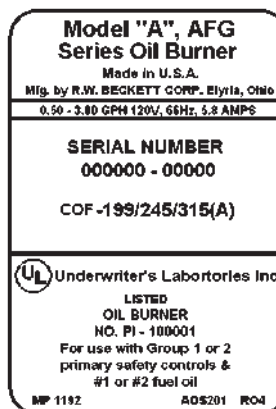

## IDENTIFICATION

The heater and burner rating plates or labels provide valuable information. When ordering parts or inquiring about a unit, be sure to include all information from the plates. See Figure 1 on page 2 for approximate location of the heater rating plate.

The heater rating plate model number, see fig. 2, includes a series number which identifies the construction of the heater.

OIL FIRED WATER HEATER				
MODEL NUMBER	SERIAL NUMBER	ITEM ID		
COF 455 940	CO5MOO6721	XXXXXXXXXX		
INPUT BTUH	FIRING RATE US GAL/HR	RECOVERY US GAL/HR	CAPACITY US GAL	MAX WORKING PRESSURE PSI
455,000	3.25	XXX.X	XX	XXX
ELECTRICAL RATINGS		CITY OF NEW YORK DEPARTMENT OF BUILDINGS MEA		
VOLTS AC	AMPS	HZ		
120	10	60		

A TYPICAL HEATER RATING PLATE  
FIGURE 2

### OIL BURNER NAMEPLATE DECAL

The oil burner's nameplate decal (see page 2 for the approximate location on the burner) contains a burner code 940 or 941 which should exactly match the model input appearing under the model number of the heater's rating plate.

If these codes do not match, the oil burner may not be the correct model for the heater model purchased, Contact your A.O. Smith - dealer for further information and replacement, if required.

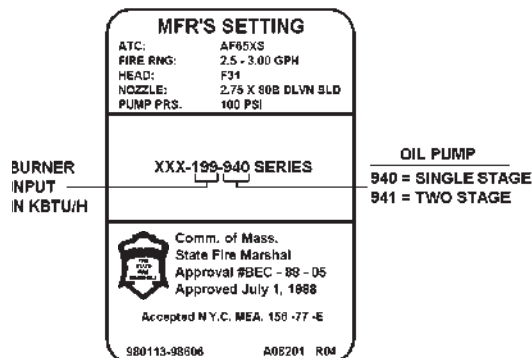

A TYPICAL OIL BURNER NAMEPLATE DECAL  
FIGURE 3

## OIL BURNER SPECIFICATIONS

The oil burner nameplate decal includes a series code which identifies the major features of the oil burner. The series number is the last three digits of the burner code number.

Table 3 below describes the oil burner characteristics for each series number. The burners are to be used with fuel oil not heavier than No. 2.

**TABLE 3 SOME NOTABLE OIL BURNER FEATURES**

A.O. Smith Burner or Heater Series Number*	R.W. Becket Burner Model Number	Safety Timing+	Oil Pump Type Mode	Suntec Oil Pump	Nozzle Type	
					Spray Pattern	Spray Angle
940	AFG SF	15 Sec.	Single Stage	A2VA 7118 A2YA-7916	Type B Solid Cone	80°
941	AFG SF	15 Sec. 15 Sec.	Two-Stage	B2VA 8216 BY2A 8916	Type B Solid Cone	80°

\* To provide the proper firing rate for each model heater, see SPECIFICATIONS: there are burner models for each heater model in table 2. The Burner and heater model numbers must match and the heater (or the burner) series number should indicate the features specified for the installation.

+ All oil burners have "interrupted ignition" . . . meaning the ignition is on during the flame establishing period only. Ignition is off when the burner is off. Standard safety timing is 15 seconds.

The heater series number determines the type of oil pump supplied with the oil burner. For installations where gravity feed of fuel oil from the storage tank to the heater is practical, an oil burner with a single-stage oil pump can be used. The 940 series of burners have single-stage pumps which are shipped for installation of a supply line to the tank only. A return line back to the storage tank can be installed, if required, by making a small modification to the pump, see the oil burner installation manual.

For installations where gravity feed cannot be employed, (the storage tank is located significantly below, or remote from, the heater) an oil burner with a two-stage oil pump should be used. The 941 series of burners have two-stage pumps which are shipped for installation of a supply and return line to the tank. However, in situations where the return line is not required (low lift installations), the pump may be modified to operate without the line, see the oil burner installation manual.

### IMPORTANT

The oil-fired water heater shipment consists of two packages, heater and oil burner. Check to be certain the model number on the heater and oil burner packages match. To assure matching equipment, see preceding information.

**TABLE 3A**

Model Heater		COF 199	COF 245	COF 315/315A	COF 385/385A	COF 455/455A	COF 700/700/A
Min. Firing Rate In GPH	A.O. Smith Burner	1.42	1.75	2.25	2.75	3.25	5.0
	Non A.O. Smith Burner	1.1	1.5	2.0	2.5	3.0	4.5

## SAFETY



**BE SURE TO TURN OFF POWER WHEN WORKING ON OR NEAR THE ELECTRICAL SYSTEM OF THE HEATER. NEVER TOUCH ELECTRICAL COMPONENTS WITH WET HANDS OR WHEN STANDING IN WATER. WHEN REPLACING FUSES ALWAYS USE THE CORRECT SIZE FOR CIRCUIT.**

If it is necessary to reset the safety control, depress red button one time only. If burner does not operate after depressing red button one time, call serviceman.

## INSTALLATION

### REQUIRED ABILITY

INSTALLATION OF SERVICE OF THIS WATER HEATER REQUIRES ABILITY EQUIVALENT TO THAT OF A LICENSED TRADESMAN IN THE FIELD INVOLVED. PLUMBING, AIR SUPPLY, VENTING , OIL BURNER AND ELECTRICAL WORK REQUIRED.

### GENERAL

The installer should be guided by these instructions, local codes and the following publications.

- Standard for the Installation of Oil Burning Equipment, NFPA Standard No. 31, Available from National Fire Protection Association, Batterymarch Park, MA 02269.
- Code for the Installation of Heat Producing Appliances, Available from American Insurance Association, 85 John Street, New York, NY 10038.
- The National Electrical Code, NFPA No. 70. Availability same as NFPA Standard No. 31.
- In Canada - CAN/CSA-B139 Installation Code for Oil Burning Equipment.

When other than an A.O. Smith burner is used, this instruction manual can be used as a general guide. The burner manufacturer's instructions will have to be consulted on specific questions of wiring, air adjustment, etc.

Do not test the burner or control system before the heater is filled with water. Follow the START-UP procedure in this manual.

### UNCRATING

Uncrate the heater by removing the outside mat and top locator. The shipping pallet must be removed from the unit. It may be possible to simply unbolt the base from the pallet and, with the help of two or more persons, work the unit off the pallet. Some units will be too heavy and will require the use of jacks or lifting equipment. Safely remove the pallet and move the unit into position. Be Careful When Moving This Heater. It will tip over easily.

### LEVELLING

Install the heater plumb to the ground. If it is necessary to adjust the heater, use metal shims under the channel type skid base.

### LOCATION

The water heater should not be installed where the combustion air is contaminated, see COMBUSTION AND VENTILATING AIR. Temperature in the location must be above 32°F (0°C) and free of combustible dusts and flammable gases or vapors.

For the best installations, the water heater should be located:

1. On a level surface.
  - Shim the channel type skid base as necessary If leveling is required.
2. Near a floor drain.
  - The heater should be located in an area where leakage of the tank or connections will not result in damage to the area adjacent to the heater or to lower floors of the structure.
  - When such locations cannot be avoided, a suitable drain pan should be installed under the heater.
  - The pan should be at least two inches deep, have a minimum length and width of at least two inches greater than the diameter of the heater and should be piped to an adequate drain. The pan must not restrict combustion air flow.

- The discharge opening of the relief valve should always be piped to an open drain.
- Choose the point of major hot water usage, fuel supply and chimney.
- Try to make hot water and oil piping as short as possible.
- Insulate hot and cold water piping where heat loss and condensation may be a problem.

## CLEARANCES

The heater has minimum clearances to combustible material, on a non-combustible floor of: 6 inches (152 mm) from the sides and rear, 24 inches (610 mm) from the front, and 18 inches (457 mm) from the vent connector. These clearances are, as shown in fig. 4A to prevent possible fire hazard conditions.

At least 24" (610 mm) of top clearances are recommended for vertical vent installation.

Allow sufficient room at rear of heater for servicing of T&P relief valve.

At least 24" (610 mm) should be provided at front of the unit for proper servicing.

Units which are to be installed on combustible flooring must be supported by a full layer of hollow concrete blocks, fig. 4, from 8" (203 mm) to 12" (305 mm) thick and extending 12" (305 mm) minimum beyond the heater in all directions. The concrete blocks must provide an unbroken concrete surface under the heater, with the hollows running continuous and horizontally. A 3/16" (4.8 mm) steel plate must cover the concrete blocks. See Figure 4.

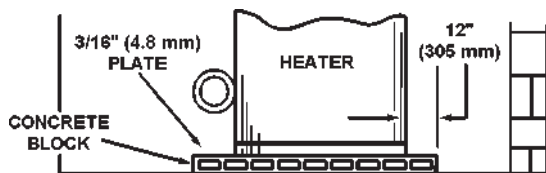

**PROPER INSTALLATION ON COMBUSTIBLE FLOORING**  
FIGURE 4

NOTE: If electrical conduits run under the floor of the proposed heater location, insulate the floor as recommended above.

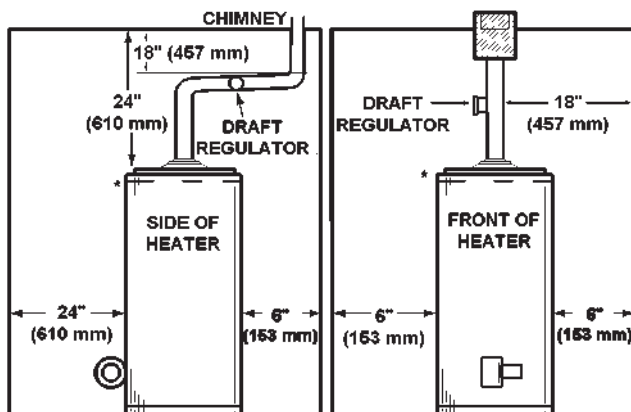

**PROPER INSTALLATION CLEARANCES FOR TWO DIFFERENT VENTING SYSTEMS**  
FIGURE 4A

- \* HOT WATER OUTLET LOCATION AT FRONT OF HEATER
- FACTORY FURNISHED HEATER MANIFOLD KITS (OPTIONAL) ARE DESIGNED FOR 10" (254 mm) SPACING BETWEEN SIDES OF ADJACENT UNITS.

## COMBUSTION AND VENTILATION AIR

### GENERAL

The water heater area should have sufficient air for satisfactory combustion of oil, and proper venting and of safe ambient temperature.

When a heater is installed in an area where exhaust or ventilating fans may create unsatisfactory combustion or venting, approved provisions must be made to overcome the problem, see NFPA Standard No. 31, Chapter 1.

## CHEMICAL VAPOR CORROSION

Water heater corrosion and component failure can be caused by the heating and breakdown of air borne chemical vapors. Spray can propellants, cleaning solvents, refrigerator and air conditioning refrigerants, swimming pool chemicals, calcium and sodium chlorides, waxes, and process chemicals are typical compounds which are potentially corrosive. These materials are corrosive at very low concentration levels with little or no odor to reveal their presence.

Products of this sort should not be stored near the heater. Also, air which is brought in contact with the water heater should not contain any of these chemicals. If necessary, uncontaminated air should be obtained from remote or outside sources.

### UNCONFINED SPACES (Building Construction)

NOTE: An uncontaminated space is defined as a space whose volume is not less than 50 ft<sup>3</sup> per 1000 BTUH (4.83m<sup>3</sup> per kW) of total input of all fuel burning appliances installed in that space. The unconfined space may be thought of as extending to all areas which cannot be separated by a door or door(s). All other spaces not fitting this description, should be thought of as confined space.

1. In unconfined spaces in buildings of conventional frame, brick or stone construction, infiltration will normally supply an adequate amount of air for combustion and ventilation.
2. If the unconfined space is within a building of tight construction, eg. weather stripping, heavy insulation, caulking, vapor barrier, ect., air infiltration may be insufficient to support proper combustion and ventilation, air shall be obtained from outdoors or from spaces freely communicating with the outdoors.

- Follow the instructions under Part 2 of Confined Spaces (Room Construction)

### CONFINED SPACES (Room Construction)

1. All air from inside building (conventionally constructed buildings only): The confined space shall be provided with two permanent openings, one within 12" (305 mm) of the ceiling and one within 12" (305 mm) of the floor, fig. 5.

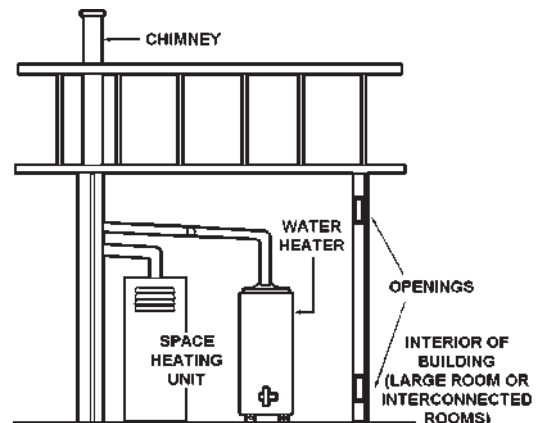

FIGURE 5

- Each opening shall have a free area of not less than one square inch per 1,000 Btu per hour (140 square inches per gallon of oil consumed per hour) of the total input rating of all appliances in the enclosure, freely communicating with the interior areas having in turn adequate infiltration from the outside. In all cases, each opening shall not have a free area of less than 100 square inches.
2. All Air From Outdoors: The confined space shall be provided with two permanent openings, one in or within 12" of the top of the enclosure and one in or within 12" of the bottom. The openings shall communicate directly, or by means of ducts, with outdoors or such spaces that freely communicate with outdoors.
- If the appliance room is located against an outside wall and the air openings communicate directly with the outdoors, each opening shall have a free area of not less than one square inch per 4,000 Btu per hour (35 square inches per gallon of oil consumed per hour) of the total input rating of all appliances in the enclosure.

- When communicating with outdoors by means of vertical ducts, each opening shall have a free area of not less than one square inch per 4,000 Btu per hour (551 mm<sup>2</sup>/kW) (35 square inches per gallon of oil consumed per hour) of total input rating of all appliances in the enclosure.
- If horizontal ducts are used, each opening shall have a free area of not less than one square inch per 2,000 Btu per hour (1,101 mm<sup>2</sup>/kW) (70 square inches per gallon of oil consumed per hour) of total input of all appliances in the enclosure, fig. 6.

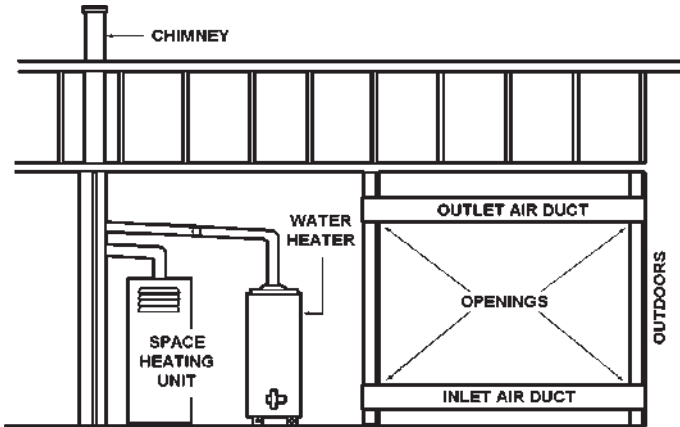

FIGURE 6

### FLUE GAS VENTING

In the absence of any local codes, regulations, or vent pipe or chimney manufacturer's recommendations, for oil fired equipment, follow the suggestions below for designing and installing a venting system.

For these water heaters, it is recommended that an adequate chimney be used for venting the flue gases. Type B, double wall, vent pipe should be used as the vent connector pipe. However, where no chimney is available, vent pipe may be used to construct a vent.

Where an existing chimney or vent is to be used, be sure that the chimney or vent has adequate capacity for the number and sizes of appliances being vented through it. Inspect the chimney or vent and remove all soot or other obstructions which will retard free draft.

### VENT CONNECTOR AND DRAFT REGULATOR

The chimney or vent connector diameter should be the same size as the heater flue outlet, see Table 4. A minimum rise of 1/4" per foot (21 mm/M) of horizontal connector length must be maintained between the heater and chimney opening, fig. 7. The connector length should be kept as short as possible.

TABLE 4 SUGGESTED VENT CONNECTOR SIZES

Model Number	Outlet Diameter	
	Inches	(mm)
COF-199*	6	152.4
COF-245	8	203.2
COF-315/315A	8	203.2
COF-385/385A	8	203.2
COF-455/455A	8	203.2
COF-700/700A	10	254

\* These models are factory supplied with a flue reducer which should be installed on the top cover.

In venting systems where a continuous or intermittent back (positive) draft is found to exist, the cause must be determined and corrected. In some cases, a special vent cap may be required.

If the back draft cannot be corrected by normal methods or if a suitable draft cannot be obtained, additional make up air must be provided to the room to assure proper venting and combustion.

Note: A negative draft must be maintained in the vent piping.

The barometric draft regulator must be installed in the same room as the heater, fig. 6. Locate the regulator as close as possible to the heater and at least 18" (452 mm) from a combustible ceiling or wall. A manually operated damper should not be placed in the chimney connector.

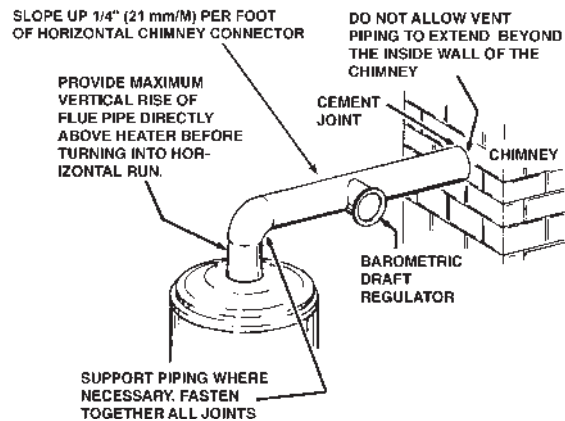

PROPER VENT CONNECTOR INSTALLATION

FIGURE 7

### CHIMNEY

The oil-fired water heater must be connected to a chimney built in accordance with accepted building code practice or listed factory built type, Table 5. The exit point of the chimney flue gas must be at least 3' (0.91M) above the highest point where it passes through the roof of a building. Also, it must be at least 2' (0.61M) higher than any portion of a building within 10' (3.05 M) of the chimney.

TABLE 5 - USUAL CHIMNEY SIZES FOR UNITS

Model Number	Oil Firing Rate		Equivalent Heat Input Rate		Output Heat Rate		Square & Rectangle Stack Dimension		Round Stack Diameter		Minimum Height	
	(GPH)	(LPH)	Btuh	kW	Btuh	kW	Inches	mm	Inches	mm	Feet	Metres
COF-199	1.42	5.38	199,000	58	159,200	47	8 1/2 X 8 1/2	216 x 216	9	228.6	20	6.1
COF-245	1.75	6.62	245,000	72	196,000	57	8 1/2 X 8 1/2	216 x 216	9	228.6	20	6.1
COF-315/315A	2.25	8.52	315,000	92	252,000	74	8 1/2 X 13	216 x 330	10	254	30	9.1
COF-385/385A	2.75	10.41	385,000	113	308,000	90	8 1/2 X 13	216 x 330	10	254	30	9.1
COF-455/455A	3.25	12.30	455,000	133	364,000	107	13 X 13	330 x 330	12	304.8	35	10.7
COF-700/700A	5.0	18.93	700,000	205	560,000	164	13 X 18	330 x 457	14	355.6	40	12.2

## MULTIPLE HEATER FLUES

When two or more oil-fired water heaters are connected to a single chimney or vent there shall be sufficient draft available for safe combustion and removal of combustion products to the outdoors from each heater. Refer to local codes for connection details.

Only one oil-fired water heater should be connected to any one type L venting system.

A draft regulator shall be provided for each oil-fired water heater in a multiple heater system.



### **DANGER**

**INCORRECT INSTALLATION CAN CAUSE IMPROPER OPERATION, FIRE, ASPHYXIATION, SERIOUS PERSONAL INJURY OR DEATH. NEVER OPERATE THIS WATER HEATER UNLESS IT IS PROPERLY VENTED TO THE OUTDOORS AND HAS ADEQUATE COMBUSTION AIR SUPPLY.**

## WATER PIPING

### GENERAL

Select the piping diagram for the type of system to be installed from pages 15 through 19. When a circulation pump is used in the system a plug cock should be installed where indicated to regulate water flow through the heater.

### RELIEF VALVE

An CSA design-certified and A.S.M.E.-rated temperature and pressure relief valve is installed in the water heater. The relief valve has a discharge capacity exceeding the maximum heater input rating and a pressure rating not exceeding the working pressure shown on the rating plate of the heater.

A temperature and pressure relief valve must also be installed on any potable water storage tank. This relief valve should have a temperature rating of 210° F (98.8°C), a pressure rating not exceeding the lowest rated working pressure of any system component, and a discharge capacity exceeding the total input of the water heaters supplying water to the storage tank.

**THE PURPOSE OF A RELIEF VALVE IS TO AVOID EXCESSIVE PRESSURE OR TEMPERATURE INTO THE STEAM RANGE, WHICH MAY CAUSE SCALDING AT FIXTURES, TANK EXPLOSION, SYSTEM OR HEATER DAMAGE.**

To avoid scalding or water damage, a drain line must be connected to a relief valve to direct discharge to a safe location, **A DRAIN LINE MUST NOT BE REDUCED FROM THE SIZE OF THE VALVE OUTLET AND IT MUST NOT CONTAIN ANY VALVES BETWEEN THE HEATER AND THE RELIEF VALVE OR THE RELIEF VALVE AND THE DRAIN LINE EXIT. IN ADDITION, THERE SHOULD NOT BE ANY RESTRICTIONS IN A DRAIN LINE NOR SHOULD IT BE ROUTED THROUGH AREAS WHERE FREEZING CONDITIONS MIGHT OCCUR. DO NOT THREAD OR CAP THE DRAIN LINE EXIT. RESTRICTING OR BLOCKING A DRAIN LINE WILL DEFEAT THE PURPOSE OF THE RELIEF VALVE AND MAY CREATE AN UNSAFE CONDITION.** Install a drain line with a downward slope such that it naturally drains itself.

Your local code authority may have other specific relief valve requirements.

NOTE: These heaters are equipped with an automatic burner shutoff system actuated by high water temperature.

## CLOSED WATER SYSTEM

A closed system will exist if a back-flow preventer (check valve), pressure reducing valve, or other similar device is installed in the cold water line between the water heater and the street main (or well). Excessive pressure may develop due to the thermal expansion of heated water causing premature tank failure or intermittent relief valve operation. This type of failure is not covered by the limited warranty. An expansion tank may be necessary in the cold water supply to alleviate this situation, see installation diagrams on pages 15-19. Contact the local plumbing authority.

## DRAIN VALVE AND ACCESS PANELS

The heaters are equipped with a 3/4" NPT drain valve mounted above and to the left of the oil burner, see FEATURES, page 2.

An access panel is located above and to the left of the oil burner and covers the flame observation port, fig. 8. A plug is inserted into the flame observation port and must be removed in order to look into the combustion chamber. Always reinstall plug before replacing access panel.

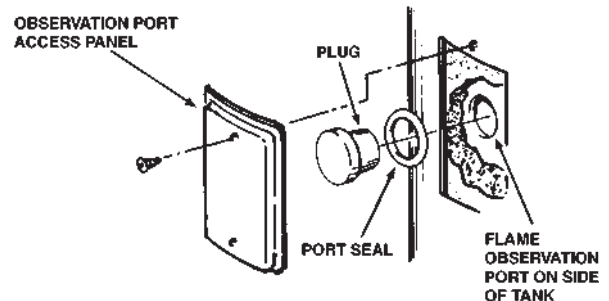

COMBUSTION CHAMBER ACCESS PORT - FIGURE 8

Another access panel is located above and to the right of the oil burner, fig. 9. This panel covers the cleanout opening in the tank which is sealed by a gasket and cover.

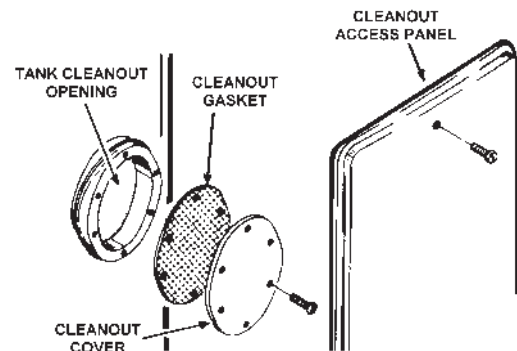

TANK CLEANOUT PORT - FIGURE 9

Models having ASME tank construction will have two cleanout ports. One port will be located as indicated above and the other will be located directly opposite.

Occasionally, some water seepage will occur at a cleanout port. To correct this situation, slightly tighten the cleanout cover bolts until the seepage is eliminated. Do not over tighten the bolts or the cleanout gasket will be damaged. Tighten each bolt gradually and alternate between opposed bolts on the cleanout cover.

## FUEL SYSTEMS

### GENERAL

The Standard for the Installation of Oil Burning Equipment-NFPA No. 31, local codes, and these instructions must be followed when installing the tank, piping and burner. In addition, an oil pump installation sheet and oil burner certificate are packed with the burner for use and completion by the installer.

On fuel systems with high pressures, a Webster "OSV" oil safety valve (Webster Electric CO., Racine, Wisc.) will be required to reduce the oil pressure at the burner pump. See FUEL PUMP, page 9, for pressure ratings of the burner's pump.

This manual and the completed oil burner certificate (CS75) are to be left with the user for future reference.

Figure 10 shows a typical single stage one or two line fuel system. When two or more tanks are connected to one burner, the supply line from each tank should run to a header fitted with an approved three-way valve. Normally only one tank may be drawn at a time unless local codes permit simultaneous feeding of two tanks on gravity type installations.

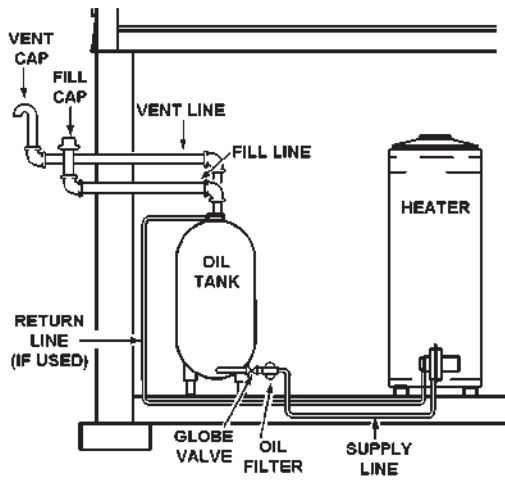

**A TYPICAL HEATER INSTALLATION - FIGURE 10**

Refer to pages 2, 3, and 4 in this manual for more information about burner series numbers and characteristics for adaptability to the following systems.

**SYSTEM TYPES**

Single Stage, Supply Line Only: The bottom of the oil storage tank must be above the level of the fuel unit, fig. 11. The fuel oil will flow by gravity to the burner. A single pipe is run between the tank and fuel unit. Burner Series No. 940 is from this type of service as shipped (the bypass plug is not installed).

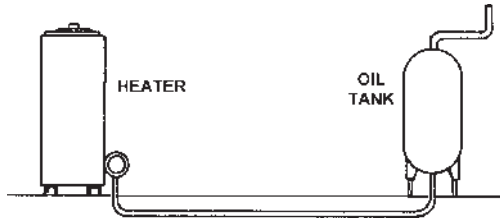

**A GRAVITY FEED, SUPPLY LINE ONLY, INSTALLATION FIGURE 11**

If the bottom of the oil tank is at least 2 inches (50.8 mm) higher than the plug opening at which the supply line connects to the fuel pump, a single-line gravity-feed system with 3/8" O.D. tubing may be used with a maximum run length of 100 feet.

- A two stage pump may be used on one line, gravity feed installations. The pump will function as a single stage unit when the by-pass plug is not installed.
- Single Stage, Supply and Return Lines. This type of system, fig. 12, is self-priming. Burner Series No. 940 with by-pass plug field installed, is for this type of service.

If the tank bottom is no lower than 10 feet below the plug, a single stage pump may be used but, it must be a two line system with maximum tubing runs (which includes lift) as shown in Table 6.

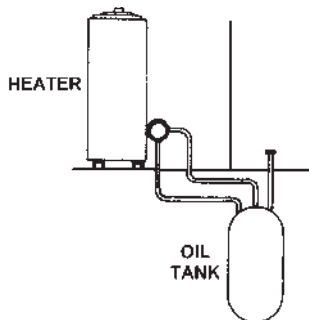

**A SINGLE STAGE (LOW LIFT), SUPPLY AND RETURN LINE INSTALLATION - FIGURE 12**

**TABLE 6**

Distance Tank Bottom Below Pump Plug Ft. (M)	Max. Run length Ft. (M)		Distance Tank Bottom Below Pump Plug Ft. (M)	Max. Run Length Ft. (M)	
	3/8" O.D. Tubing	1/2" O.D. Tubing		3/8" O.D. Tubing	1/2" O.D. Tubing
1 (0.3)	66 (20.1)	100 (30.4)	6 (1.8)	36 (10.9)	100 (30.4)
2 (0.6)	55 (16.7)	100 (30.4)	7 (2.1)	31 (9.4)	100 (30.4)
3 (0.9)	50 (15.2)	100 (30.4)	8 (2.4)	26 (7.9)	100 (30.4)
4 (1.2)	45 (13.7)	100 (30.4)	9 (2.7)	21 (6.4)	83 (25.2)
5 (1.5)	40 (12.1)	100 (30.4)	10 (3.0)	16 (4.8)	64 (19.5)

Two Stage, Supply and Return Lines: This system, fig. 13, is required when long lines and high lifts (requiring up to 20" of vacuum and 10' vertical lift) are encountered. Burner Series No. 941 is used in this service. Bypass plug must be installed.

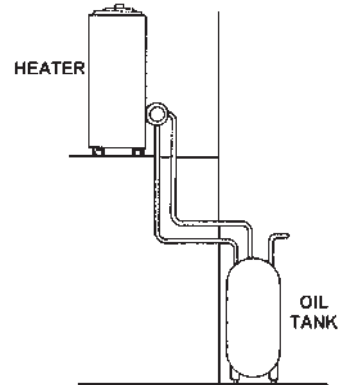

**A TWO STAGE (HIGH LIFT), SUPPLY AND RETURN LINE INSTALLATION - FIGURE 13**

If the tank(s) bottom is lower than the plug by more than 10 feet, a two stage pump with a two line system must be used with maximum tubing runs (which includes lift) as shown in Table 7.

**TABLE 7**

Distance Tank Bottom Below Pump Plug Ft. (M)	Max. Run length Ft. (M)		Distance Tank Bottom Below Pump Plug Ft. (M)	Max. Run Length Ft. (M)	
	3/8" O.D. Tubing	1/2" O.D. Tubing		3/8" O.D. Tubing	1/2" O.D. Tubing
1 (0.3)	74 (22.5)	100 (30.4)	9 (2.7)	51 (15.5)	100 (30.4)
2 (0.6)	71 (21.6)	100 (30.4)	10 (3.0)	48 (14.6)	100 (30.4)
3 (0.9)	69 (21.0)	100 (30.4)	11 (3.3)	45 (13.7)	100 (30.4)
4 (1.2)	66 (20.1)	100 (30.4)	12 (3.6)	42 (12.8)	100 (30.4)
5 (1.5)	63 (19.2)	100 (30.4)	13 (3.9)	39 (11.8)	100 (30.4)
6 (1.8)	60 (18.2)	100 (30.4)	14 (4.2)	37 (11.2)	100 (30.4)
7 (2.1)	57 (17.3)	100 (30.4)	15 (4.5)	34 (10.3)	100 (30.4)
8 (2.4)	54 (16.4)	100 (30.4)			

**MULTIPLE HEATER FUEL LINES**

Where two or more heaters form a water heating system, each burner shall have an entirely separate oil supply line from the tank to the burner.

**BURNER INSTALLATION**

**GENERAL**

An oil Burner Certificate is packed with the oil burner. Following the burner manual installation the necessary tests shall be performed and results recorded on the certificate, see BURNER CERTIFICATE. The certificate and this instruction manual must be left with user for future reference.

Check to be certain the heater and burner model numbers are alike and the oil pump characteristics are proper for the job. See IDENTIFICATION, page 3.



## BURNER

The burner assembly is mounted on the flange of the combustion chamber, fig. 14.

NOTE: Be certain combustion chamber opening is aligned with opening in heater flange, fig. 14, before placing burner into heater .

1. Place the flange gasket over the 3/8" x 1/4" long studs on the flange.
2. Place the burner flange on the studs and into the heater flange opening.

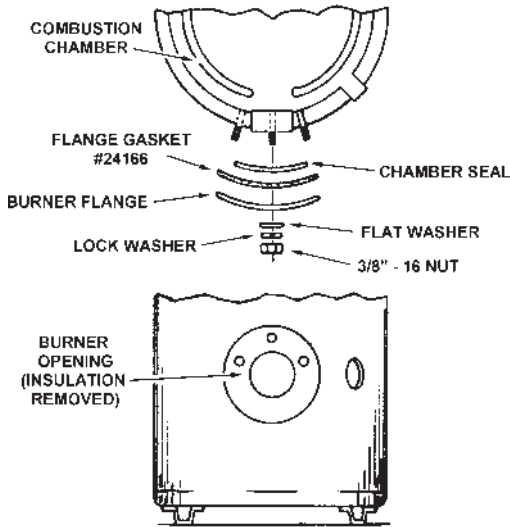

ASSEMBLY OF THE OIL BURNER TO THE HEATER  
FIGURE 14

3. Place the flat washers and lock washers over the studs and fasten the burner in place with the 3/8" - 16 nuts as shown.

Connect the oil line(s) and electrical wires to the burner as follows:

1. The oil pump manufacturer's instructions should be checked for connection and bleeding information.
2. An approved, separately fused circuit with disconnect switch should be available for the oil burner. Using Figure 15, the wiring diagram below as a guide:
  - The burner is approved for use with fuel oil not heavier than No. 2.
  - Route the 120 volt incoming line in the dual bulb thermostat, mounted on the side of the heater.

- Bring the factory wiring from the high limit /eco and thermostat into the oil burner junction box.
  - Install field and factory wiring as shown in the wiring diagrams, figs. 15. A schematic diagram is also shown for convenience when servicing.
  - Ground the heater in accordance with the NEC code to guard against electrical shock from the heater or water system.
3. All oil burners have "interrupted ignition". . . meaning the ignition is on during the flame establishing period only.
  4. Do not "test fire" the heater to complete the oil burner certificate until the tank is filled with water, see the oil burner manual.

The certificate and this manual must be left with the user for future reference.

TABLE 8 - OIL PUMP & NOZZLE SPECIFICATIONS

Heater Model	Fitting Rate (GPH)		Oil Burner Pump Non-Setting PSIG	Oil Burner Nozzle Type	Oil Burner Nozzle Rating (GPH)
	State Burner	Non State Burner			
COF-199	1.42	1.1	110	80°B	1.35
COF-245	1.75	1.5	100	80°B	1.75
COF-315/315A	2.25	2.0	100	80°B	2.25
COF-385/385A	2.75	2.5	100	80°B	2.75
COF-455/455A	3.25	3.0	100	80°B	3.25
COF-700/700A	5.00	4.5	100	80°B	5.00

## FUEL PUMP

### GENERAL

All heaters are shipped with the pump pressure set at 100 psig except the COF-199 which is set at 110 psig.

All oil pumps are fitted for installation on single fuel line systems. The pump may be adapted for two line service by using the by-pass Plug and pump manufacturer's instructions packed with the burner.

The single-stage pumps are for single-pipe or two-pipe installations, either lift or gravity feed. On gravity feed installations the inlet pressure is not to exceed 3 psig. On one pipe lift installations the lift is not to exceed 8 ft.

The two-stage pumps are for two-pipe lift installations where the inlet vacuum does not exceed 20" hg. vacuum.

AIR BLEED PROCEDURE (Refer to oil burner manual).

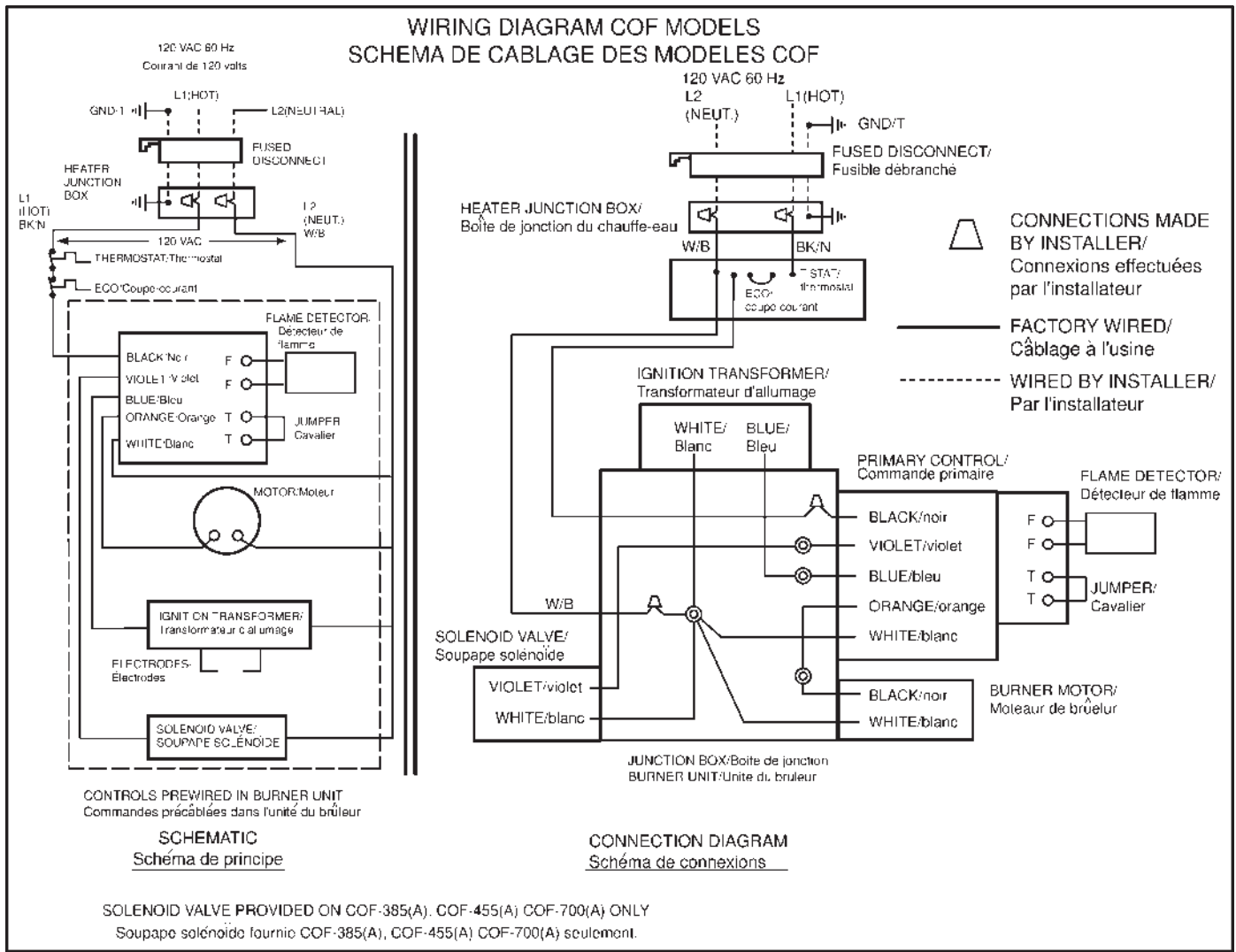

FIGURE 15

## OPERATION

### GENERAL

Never operate the heater unless the tank is filled with water and a temperature and pressure relief valve is installed.

### FILLING

1. Oil burner electrical disconnect switch should be in the "OFF" position
2. Close the heater drain valve.
3. Open a nearby hot water faucet to allow the air in the system to escape.
4. Fully open the cold water inlet valve, filling the heater and piping.
5. Close the hot water faucet as water starts to flow from the opening, Leave the cold water inlet valve fully open. The heater is now ready to start-up if being placed in operation for the first time.

### START-UP

Factory Start-Up is required for activating warranty and assuring maximum operating performance. Contact your local sales representative or Authorized Start-Up Agent to arrange a FREE Certified Start-Up.

The following checks should be made by the installer when the heater is placed into operation for the first time:

1. Check all factory and field made water, oil and electrical connections for tightness. Also check flue gas disposal provisions on top the heater.

- Repair any water and oil leaks. Tighten electrical and flue connections as necessary.

2. Where the water heater or water heating systems includes a circulating pump, it may need to be lubricated before operated. The tube of lubricant supplied with the pump includes directions for use.

- Field installed circulating pumps should be all bronze construction.

Be sure the oil burner, related piping, valves and controls are in place, adjusted and ready for operation before turning on the electricity.

3. Adjust the heater mounted control as follows:

- THERMOSTAT (adjustable) set for desired water temperature.
- It is suggested the thermostat be turned to the lowest setting which satisfies the hot water requirements of the system. This helps minimize scale formation in the heater.
- HIGH LIMIT (not adjustable, manual reset) factory set to cutout at 195° F (90.5°C).
- If the high limit is actuated, the safety primary control will cause the oil burner to shut down. See SAFETY PRIMARY CONTROL, page 22.
- To reset the safety primary control, depress and hold the red button on the control for 30 seconds until the LED flashes twice.
- Depress red button one time only. If burner does not operate after depressing red button one time, call service man.

4. Turn on the oil burner electrical disconnect switch.

5. The heater will begin normal operation on the thermostat's "call for heat".

- To turn the heater off, open the electrical disconnect switch. If the heater is to remain inoperative for a long period of time, close the shutoff valve on the oil supply line.

## WATER TEMPERATURE CONTROL



THIS WATER HEATER IS EQUIPPED WITH AN ADJUSTABLE THERMOSTAT TO CONTROL WATER TEMPERATURE. HOT WATER TEMPERATURES REQUIRED FOR AUTOMATIC DISHWASHER AND LAUNDRY USE CAN CAUSE SCALD BURNS RESULTING IN SERIOUS PERSONAL INJURY AND OR DEATH. THE TEMPERATURE AT WHICH INJURY OCCURS VARIES WITH THE PERSONS AGE AND TIME OF EXPOSURE. THE SLOWER RESPONSE TIME OF CHILDREN, AGED OR DISABLED PERSONS INCREASES THE HAZARDS TO THEM. NEVER ALLOW SMALL CHILDREN TO USE A HOT WATER TAP, OR TO DRAW THEIR OWN BATH WATER. NEVER LEAVE A CHILD OR DISABLED PERSON UNATTENDED IN A BATHTUB OR SHOWER.

THE WATER HEATER SHOULD BE LOCATED IN AN AREA WHERE THE GENERAL PUBLIC DOES NOT HAVE ACCESS TO SET TEMPERATURES.

SETTING THE WATER HEATER TEMPERATURE AT 120°F (48.9°C) WILL REDUCE THE RISK OF SCALDS. Some states require settings at specific lower temperatures.

Figure 16 shows the approximate time-to-burn relationship for normal adult skin. Short repeated heating cycles caused by small hot water uses can cause temperatures at the point of use to exceed the thermostat setting by up to 20°F. If you experience this type of use, you should consider using lower temperature settings to reduce scald hazards.

Water Temperature °F	Time for 1 <sup>st</sup> Degree Burns (Less Severe Burns)	Time for Permanent Burns 2nd & 3rd Degree (Most Severe Burns)
110	(normal shower temp.)	
116	(pain threshold)	
116	35 minutes	45 minutes
122	1 minute	5 minutes
131	5 seconds	25 seconds
140	2 seconds	5 seconds
149	1 second	2 seconds
154	instantaneous	1 seconds

(U.S. Government Memorandum, C.P.S.C., Peter L. Armstrong, Sept. 15, 1978)

FIGURE 16

Valves for reducing point-of-use temperature by mixing cold and hot water are available. Also available are inexpensive devices that attach to faucets to limit hot water temperatures. Contact a licensed plumber or the local plumbing authority.

The water temperature is controlled by a thermostat, fig. 17, which has two sensing elements. One sensor is located near the top of the tank and the other is near the center. The thermostat is set in the lowest position before the heater leaves the factory.

The thermostat temperature dial, fig. 17, is accessible by taking off the access cover and removing the control cover. The dial is adjustable

and may be set for 120° (48.9°C) to 180°F (82.2°C) water temperature, but 120°F (48.8°C) is the recommended starting point. It is suggested the dial be placed in the lowest setting which produces an acceptable hot water supply. This will always give the most energy efficient operation. The temperature control has a 4°F (2.2°C) fixed differential.

## HIGH LIMIT SWITCH (E.C.O)

The dual bulb controller (fig.17) contains the high limit (energy cutoff) sensor. The high limit switch interrupts main burner gas flow should the water temperature reach 195°F (90.5°C).

In the event of high limit switch operation, the appliance cannot be restarted unless the water temperature is reduced by 20°F (11.1°C) (approx.) and the high limit reset button on front of limit control (fig. 17) is depressed.

Continued manual resetting of high limit control, preceded by higher than usual water temperature is evidence of high limit switch operation. Contact your dealer or servicer if continued high limit switch operation occurs.

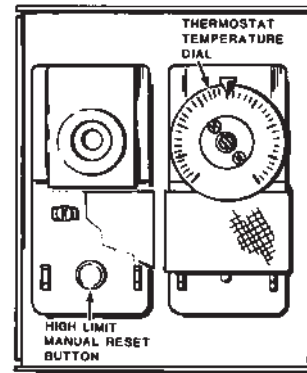

DUAL-BULB THERMOSTAT (COVER REMOVED)

FIGURE 17

## BURNER CERTIFICATE (COMBUSTION TEST)

The Commercial Standard CS75 Oil Burner Certificate form must be filled in and posted in the vicinity of the water heater.

Instructions for filling in certificate are on the back of the certificate. This must be done by the installer at the time the heater is first operated. The certificate is in the oil burner manual.

## SELF-CLEANING ELIMINATOR

These units include a self-cleaning eliminator installed in the front water inlet. See figure 18. The eliminator must be oriented correctly for proper function. There is a marked range on the pipe nipple portion of the eliminator, that must be aligned with the top of the inlet spud. A label above the jacket hole has an arrow that will point to the marked portion of the pipe nipple if the orientation is correct. If the arrow does not point within the marked range on the pipe nipple, adjust the pipe nipple to correct. A pipe union is supplied with the eliminator to reduce the probability of misaligning the eliminator accidentally while tightening the connection to the inlet water supply line. Improper orientation of the eliminator can cause poor performance of the heater and can significantly reduce outlet water temperatures during heavy draws.



FIGURE 18

## DRAINING

The water heater must be drained if it is to be shut down or exposed to freezing temperatures. Maintenance and service procedures may also require draining the heater.

- Turn off the oil burner electrical disconnect switch.
  - If required by the reason for draining the heater, turn off the oil line supply valve.
- Close the cold water inlet valve to heater.
- Open a nearby hot water faucet to vent the system.
- Open the heater drain valve.
- If the heater is being drained for an extended shutdown, it is suggested the drain valve be left open during this period.
  - Follow FILLING instructions when restarting hot water service.

## MAINTENANCE

### GENERAL

Water heater maintenance includes periodic tank flushing and cleaning, and removal of lime scale. The oil burner should be inspected and adjusted to maintain proper combustion. Where used, the water heating system circulating pump should be oiled (See table 9).

The depth of lime buildup should be measured periodically. Heaters will have about 2" (50.8 mm) of lime buildup when the level of lime has reached the bottom of the cleanout opening or about 1" of lime buildup if it has reached the drain valve opening. A schedule for deliming should be setup, based on the amount of time it would take for a 1" (25.4 mm) buildup of lime.

Example 1: Initial inspection shows 1/2" (12.7 mm) of lime accumulation. Therefore, the heater can be delimed once a year.

Example 2: Initial inspection shows 2" (50.8 mm) of lime accumulation. Therefore, the heater should be delimed every 3 months.

Following are the instructions for performing some of the recommended maintenance. Oil burner inspection and adjustment should be performed by a competent technician.

TABLE 9 SUGGESTED MAINTENANCE SCHEDULE

Relief Valve	Lift Lever	Semi-Annually	
Tank	Flushing	Monthly	
	Sediment Removal	Semi-Annually	
	Anode Inspection	Semi-Annually	
	Lime Scale Removal	As Required	UN-LIME® Delimer
Circulating Pump	Oiling	Four Months	SAE No. 20 non-detergent motor oil
Oil Burner	Inspection and Adjustment	Semi-Annually	Combustion test kit & test specifications (Page 26)
	Nozzle Replacement	Semi-Annually	New Nozzle
Flue Baffle Pipe	Cleaning	Annually	Wire Brush
Venting System	Inspected	Semi-Annually	

\* Replacement gasket, A.O. Smith Part No. 99038

### RELIEF VALVES

At least twice a year, the system relief valves should be checked to ensure that they are in operating condition. To check a relief valve, lift the lever at the end of the valve several times. The valve should seat properly and operate freely.

If water does not flow, remove the valve and inspect for obstructions or corrosion. Replace with a new valve of the recommended size as necessary. Inspection of the valve should be performed at least every three years. Do not attempt to repair the valve, as this could result in improper operating and a tank explosion. In areas with poor water conditions, it may be necessary to inspect the T&P valve more often than twice a year.



### DANGER

**BEFORE MANUALLY OPERATING A RELIEF VALVE, MAKE SURE THAT DRAIN LINE HAS BEEN ATTACHED TO THE VALVE TO DIRECT THE DISCHARGE TO AN OPEN DRAIN. FAILURE TO TAKE THIS PRECAUTION COULD MEAN CONTACT WITH EXTREMELY HOT WATER PASSING OUT OF THE VALVE DURING THIS CHECK OPERATION.**

If the temperature and pressure relief valve on the heater discharges periodically or continuously, it may be due to thermal expansion of water in a closed water supply system, or it may be due to a faulty relief valve.

Thermal expansion is the normal response of water when it is heated. In a closed system, thermal expansion will cause the system pressure to build until the relief valve actuation pressure is equaled. Then, the relief valve will open, allowing water to escape, slightly lowering the pressure.

Your water supplier or local plumbing inspector will know how to best correct this situation. Two common corrections are listed in the Checklist and Service Information which appears later in this manual.

**ABOVE ALL, DO NOT PLUG THE TEMPERATURE AND PRESSURE RELIEF VALVE. THIS IS NOT A SOLUTION AND CAN CREATE A HAZARDOUS SITUATION.**

### FLUSHING

- Turn off the oil burner electrical disconnect switch.
- Open the drain valve and allow water to flow until it runs clean.
- Close the drain valve when finished flushing.
- Turn on the oil burner electrical disconnect switch.

### SEDIMENT REMOVAL

Water borne impurities consist of fine particles of soil and sand which settle out and form a layer of sediment on the bottom of the tank.

For convenience, sediment removal and lime scale removal should be performed at the same time.

### LIME SCALE REMOVAL

The amount of calcium carbonate (Lime) released from water is in direct proportion to water temperature and usage, see chart. The higher the water temperature or water usage, the more lime deposits are dropped out of the water. This is the lime scale which forms in pipes, heaters and on cooking utensils.

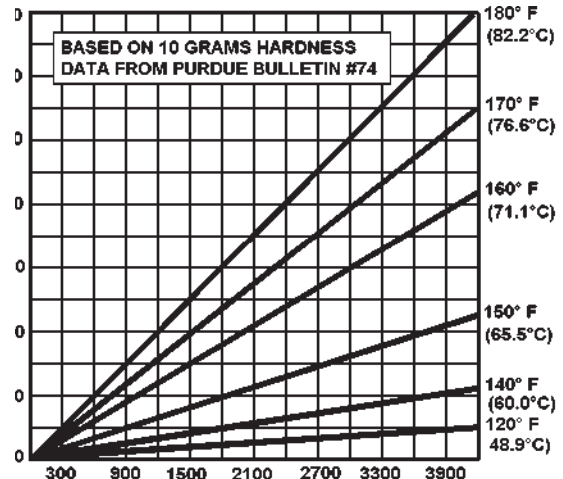

WATER USAGE IN GALLONS PER DAY POUNDS OF LIME DEPOSITED VS. TEMPERATURE AND WATER USAGE

FIGURE 18A.

Lime accumulation not only reduces the life of the equipment but also reduces efficiency of the heater and increases fuel consumption.

The usage of water softening equipment greatly reduces the hardness of the water. However, this equipment does not always remove all of the hardness (lime). For this reason it is recommended that a regular schedule for deliming be maintained.

Sediment and lime scale removal may be accomplished through the cleanout opening furnished on the water heater, see FEATURES, page 2. The heater must be drained, see DRAINING, page 12, before removing cleanout cover on tank.

To dissolve and remove the more stubborn mineral deposits, A. O. Smith UN•LIME® Professional Delimer or equivalent should be used.

A. O. Smith UN•LIME® Delimer is an easy-to-handle patented food grade acid formulated specifically for lime scale removal from all types of water using equipment and is available in 1 gallon (Part No. 4763) and 5 gallon (Part No. 4813) sizes. Hydrochloric base acids are not recommended for use on glass-lined tanks.

UN•LIME® Professional Delimer:  
Part No: 9005416105 4 - 1 Gallon (case)  
Part No: 9005417105 1 - 5 Gallon

A. O. Smith Form No. 4800, entitled Why? When? & How? describes tank cleaning methods and materials. UN•LIME® and booklet may be obtained through your A.O. Smith dealer or distributor.

To clean heater through cleanout opening, proceed as follows:

1. Turn off water inlet valve, the oil burner electrical disconnect switch and open drain valve and allow all water to be drained from heater.
2. Remove outer cover plate from lower side of heater jacket.
3. Remove six (6) hex head screws securing tank cleanout plate and remove plate.
4. Remove lime, scale, or sediment using care not to damage the glass lining.
5. Inspect cleanout plate gasket. If new gasket is required, replace with A. O. Smith Kit (Part no. 9004099215).
6. Install cleanout plate. Be sure to draw plate up tight by tightening screws securely.
7. Close drain valve, open water inlet line and turn on the oil burner electrical disconnect switch.
8. Check for water leakage.
9. Replace outer jacket cover plate.

### Flo-jug Method of Deliming

The Flo-Jug is the standard 5 gallon container for UN•LIME® -or- it is available as a deliming kit with UN•LIME®, hose and fittings. Contact your dealer, distributor or the A. O. Smith Corporation. Figure 18 illustrates most of the following steps.

1. The heater should be prepared for deliming as described in the "Why? When and How" booklet. The relief valve may also be delimed at this time.
2. With the Flow-Jug upright:
  - Take off cap, remove cover under opening and install 3/4" x 4" brass pipe nipple.

- Drill or punch a 3/16" vent hole in handle. A stainless steel screw is included with the Flo-Jug kit. This screw is to be installed in the vent hole when Flo-Jug is not in use.
- Remove drain valve from heater and insert a 3/4" x 4" drain nipple.

- Connect the clamp 1" I. D. x 3" hole to Flo-Jug and drain nipple.

3. Lift the Flo-Jug to the POUR POSITION and permit the UN•LIME® to flow into the heater as rapidly as possible.

- Be sure to keep the vent just above the liquid level.

4. Place the Flow-Jug in the DELIME POSITION.

- It may be necessary to place the empty jug on its carton to trap the solution in the heater.
- Allow the UN•LIME® to attack the water scale for 5 minutes.

5. Lower the Flo-Jug to the DRAIN POSITION and allow the UN•LIME® to flow out of the heater as rapidly as possible.

- Observe the vent hole and elevate the jug slightly if there is a possibility of spillage.

- Deliming activity is indicated by foaming on the surface of the solution.

6. Continue the deliming process:

- Raise jug to POUR POSITION. Allow solution to flood into heater.
- Place jug to DELIME POSITION for 5 minutes. Solution is at work in heater.
- Lower jug to DRAIN POSITION and allow solution to flow out. Observe foaming.

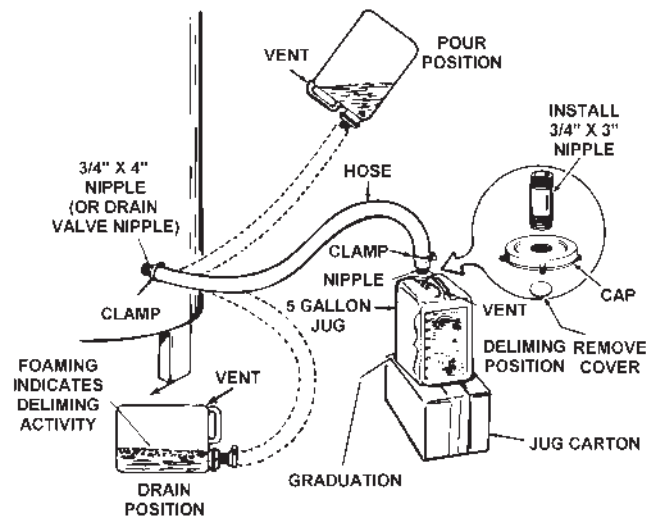

**DELIMING THE COF WATER HEATER  
FIGURE 18**

7. After one hour, or earlier if the deliming activity (foaming) stops, inspect the tank interior.

- Drain the UN•LIME® back into jug, DRAIN POSITION, and then stand jug in DELIME POSITION.
- Remove clamp, hose and pipe nipple from heater drain opening.
- Observe interior through opening - a small flashlight works well.
- If the interior still shows water scale, the deliming process should be continued.

- To check UN•LIME® for continued use or reuse, place some lime scale or white chalk into a glass with a small amount of the solution. If the material is vigorously dissolved by the solution, the UN•LIME® can be reused. If not, then UN•LIME® has been weakened and should be replaced.

8. When deliming has been completed, the heater should be flushed for 3 to 5 minutes with fresh water.

- Remove the deliming equipment, install the drain valve, open the cold water inlet line and allow water to flow through heater and out the drain valve. Don't forget to plug vent and cap opening in Flo-Jug.

9. When flushing is completed:

- Fill heater being certain to expel air from tank through a nearby hot water faucet.
- Replace relief valve, removed for deliming.
- Restore oil, water and electrical supply to heater.
- Check for water leakage.

10. Flo-Jug Cleanup.

- Allow scale to separate from UN•LIME® and settle on bottom of Flo-Jug.
- Pour off UN•LIME® into plastic container and check for reuse.
- Rinse sediment from Flo-Jug.
- If UN•LIME® is reusable, pour back into Flo-Jug. Be sure to plug vent and cap opening.

### CIRCULATING PUMP

The water heater or water heating system may include a circulating pump. Where used, it may need to be lubricated once every four months with SAE No. 20 non-detergent motor oil or as directed by the manufacturer.

- Place 2 or 3 teaspoons in the bearing oil cup and 10 to 12 drops in the motor oil cups. Lubricate as required by manufacturer.

### SOOT REMOVAL

Soot must be removed semi-annually from the heater and flow passages to insure efficient operation of the heater.

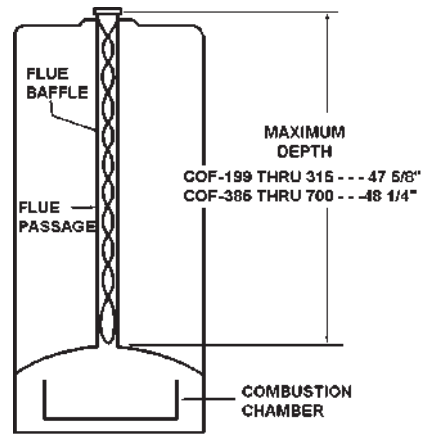

**A TYPICAL HEATER FLUEWAY AND FLUE BAFFLE  
FIGURE 19**

1. Remove chimney connector and top cover of heater from heater. Clean out all soot deposits from connector and chimney opening. A wire brush is recommended for this operation.

2. Remove flue baffles by lifting from tank.

3. Using a wire brush, remove soot from flue passages in heater tank.

**CAUTION:** While cleaning tank flue passages, care must be taken that brush does not come in contact with the top of the combustion chamber as damage could occur to the combustion chamber lining. Do not allow the brush to enter the heater flue more than noted in fig. 19.

4. Remove oil burner assembly and using a vacuum cleaner, remove all loose soot from combustion chamber area. Avoid contact with combustion chamber as it can be damaged quite easily.

- If flange gasket is damaged, replace with A. O. Smith Part No. 24165

5. Upon completion of cleaning, reassemble the heater. (It may be necessary to apply new sealer tape to the top cover to ensure proper venting. New sealer tape can be ordered from A. O. Smith Water Products Company).

6. Return the heater to operation by following the start-up instructions on page 11.

### VENT SYSTEM

Examine the vent system every six months for obstructions and/or deterioration of vent piping. Remove any soot or obstructions and replace damaged vent piping.

# INSTALLATION DIAGRAMS

## ONE TEMPERATURE - ONE HEATER VERTICAL STORAGE TANK FORCED CIRCULATION WITH OR WITHOUT BUILDING RECIRCULATION

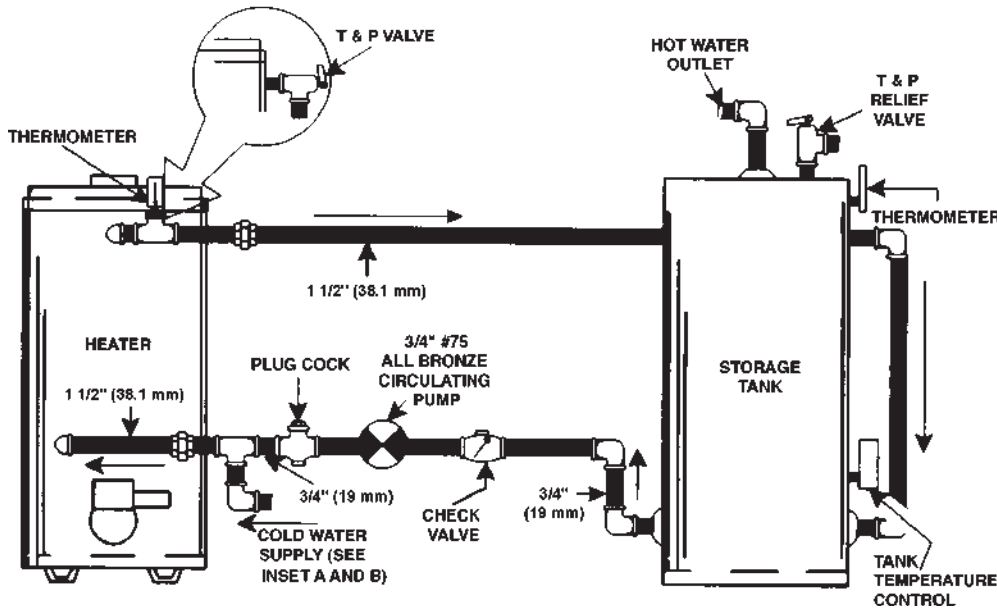

NOTE:  
WHEN USING A A.O. Smith T-140,200,350,OR 400 STORAGE TANK,  
USE LOWER 3/4" OPENING FOR TANK TEMP.CONTROL

### SCALD PREVENTION

HOT WATER CAN SCALD IF USED CARELESSLY OR IN UNANTICIPATED MANNER.



**CAUTION**  
IF BUILDING COLD WATER SUPPLY HAS A BACK FLOW PREVENTER, CHECK VALVE OR WATER METER WITH CHECK VALVE, PROVISIONS FOR THERMAL EXPANSION OF WATER IN THE HOT WATER SYSTEM MUST BE PROVIDED.

NOTE: CONNECT RETURN LINE FROM HOT WATER CIRCULATING LOOP (IF USED) TO COLD WATER INLET LINE.

## ONE TEMPERATURE - ONE HEATER HORIZONTAL STORAGE TANK FORCED CIRCULATION WITH OR WITHOUT BUILDING RECIRCULATION

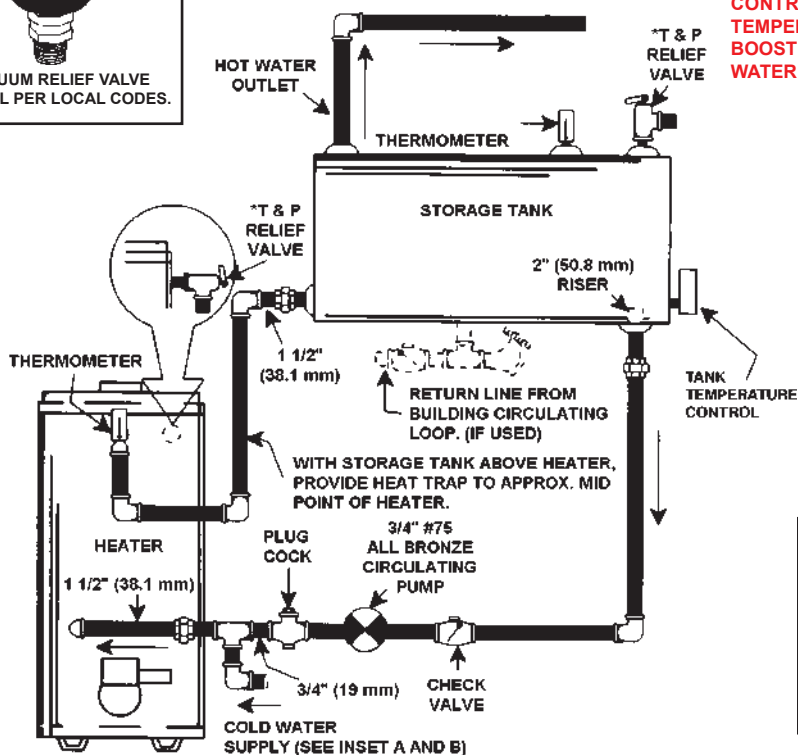
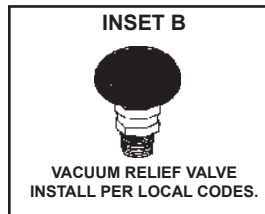

**DANGER:**  
TEMPERATURE SETTING SHOULD NOT EXCEED SAFE TEMPERATURES AT FIXTURES. SEE WATER TEMPERATURE CONTROL WARNING ON PAGE 11. IF HIGHER PREHEAT TEMPERATURES ARE NECESSARY TO OBTAIN ADEQUATE BOOSTER OUTPUT, ADD AN ANTI-SCALD VALVE FOR HOT WATER SUPPLIED TO FIXTURES.

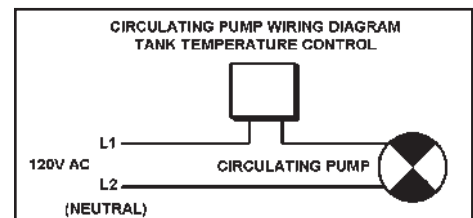
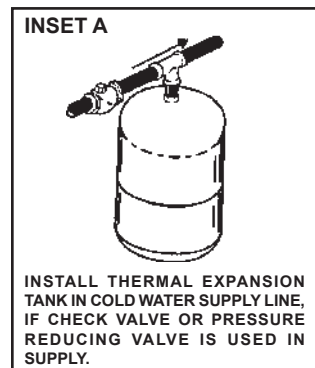

WIRING DIAGRAM FOR HEATER TO TANK LOOP AND /OR HOT WATER LOOP (IF USED)

\* PIPE TO OPEN DRAIN

INSTALL IN ACCORDANCE WITH LOCAL CODES

**SINGLE TEMPERATURE OR BOOSTER**

**⚠ DANGER:**  
 TEMPERATURE SETTING SHOULD NOT EXCEED SAFE TEMPERATURES AT FIXTURES. SEE WATER TEMPERATURE CONTROL WARNING ON PAGE 11. IF HIGHER PREHEAT TEMPERATURES ARE NECESSARY TO OBTAIN ADEQUATE BOOSTER OUTPUT, ADD AN ANTI-SCALD VALVE FOR HOT WATER SUPPLIED TO FIXTURES.

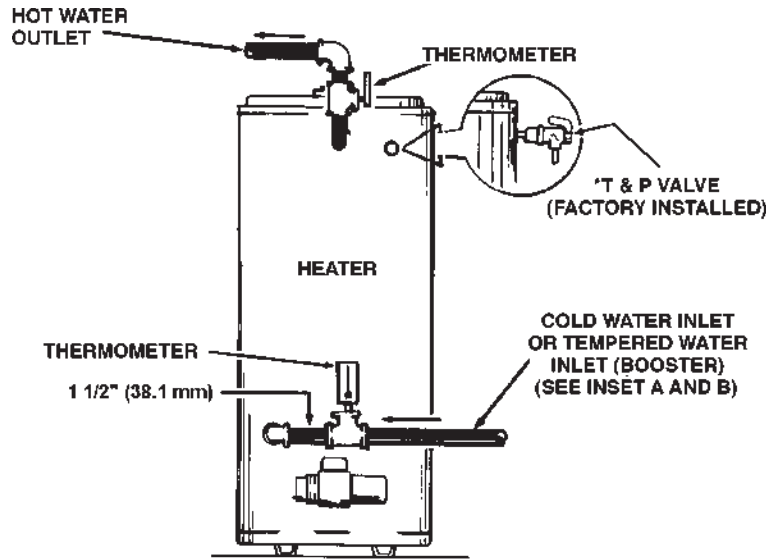

**TWO TEMPERATURE - ONE HEATER HIGH TEMPERATURE STORAGE WITH OR WITHOUT RECIRCULATION**

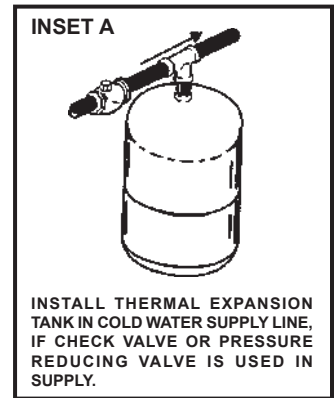
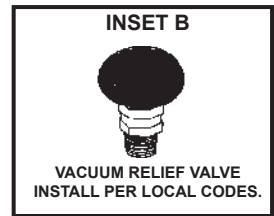
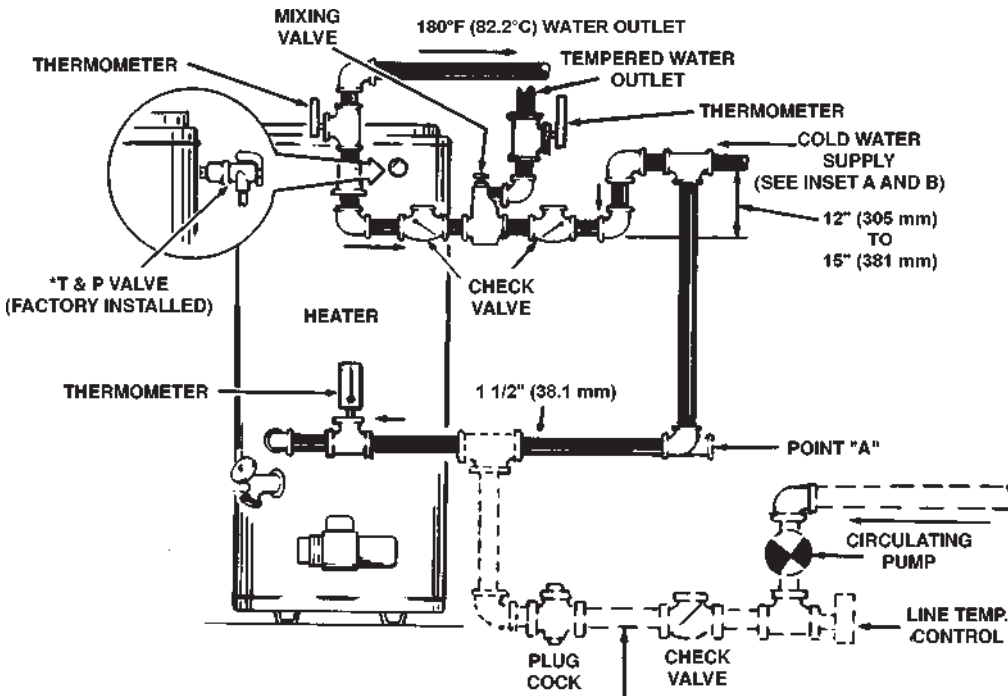

NOTE: IF TEMPERED WATER IS RECIRCULATED RETURN LINE SHOULD BE CONNECTED AT POINT "A"

RETURN LINE FROM 180°F (82.2°C) CIRCULATING LOOP (IF USED)

\* PIPE TO OPEN DRAIN

INSTALL IN ACCORDANCE WITH LOCAL CODES

WIRING DIAGRAM FOR TEMPERED WATER LOOP (IF USED)

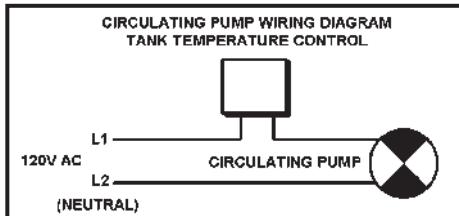

WIRING DIAGRAM FOR 180° LOOP (IF USED)

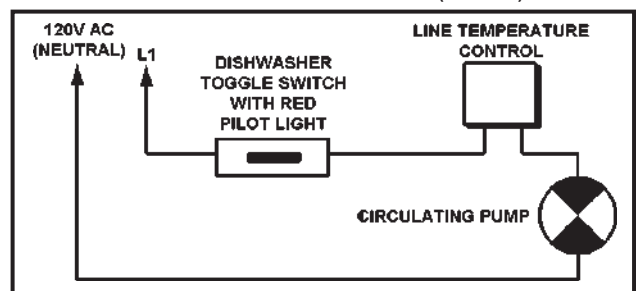



**TWO TEMPERATURE - TWO HEATERS HIGH TEMPERATURE STORAGE  
WITH OR WITHOUT RECIRCULATION**

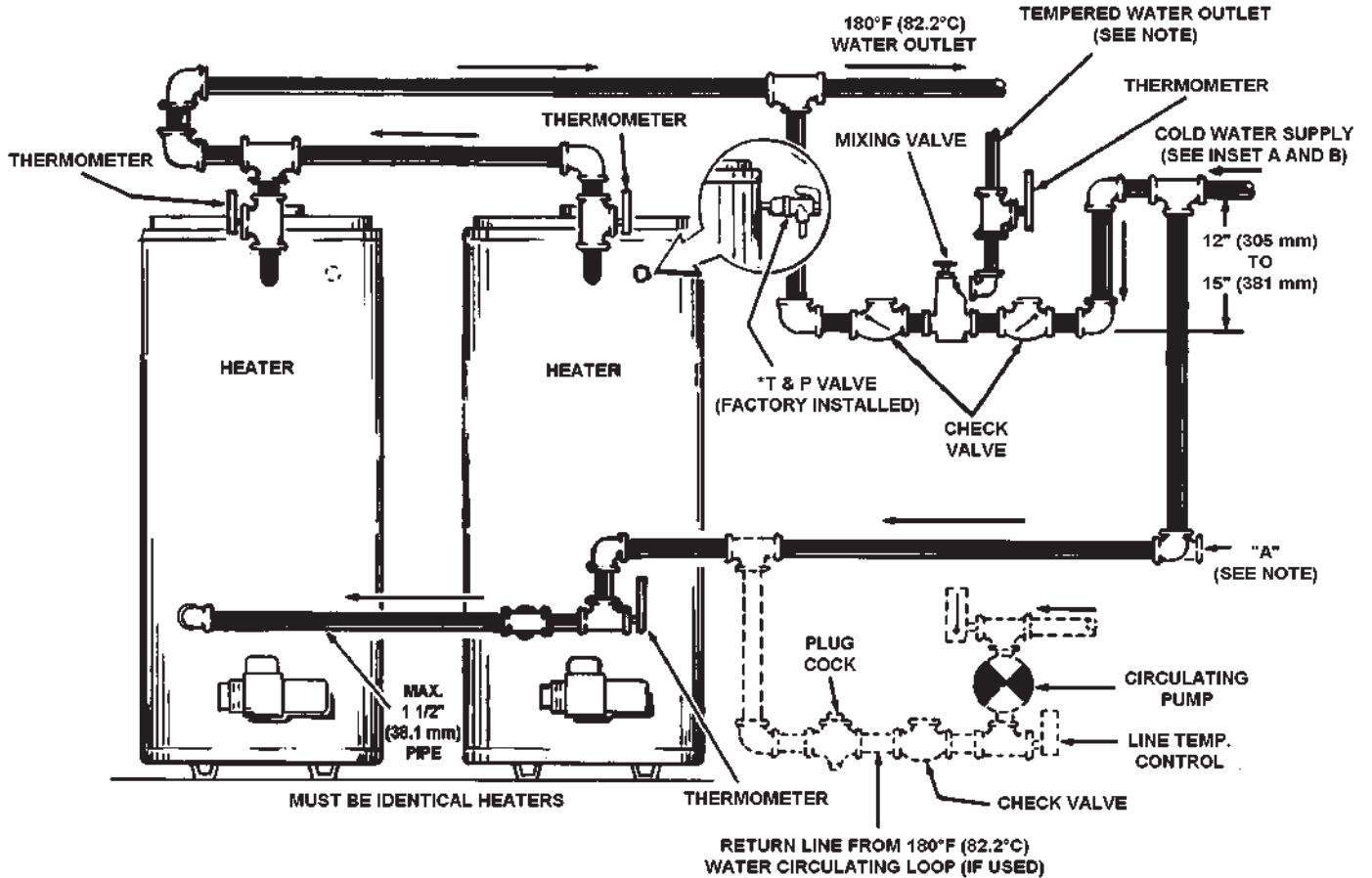

**⚠ DANGER:**  
TEMPERATURE SETTING SHOULD NOT EXCEED SAFE TEMPERATURES AT FIXTURES. SEE WATER TEMPERATURE CONTROL WARNING ON PAGE 11. IF HIGHER PREHEAT TEMPERATURES ARE NECESSARY TO OBTAIN ADEQUATE BOOSTER OUTPUT, ADD AN ANTI-SCALD VALVE FOR HOT WATER SUPPLIED TO FIXTURES.

\* PIPE RELIEF VALVE TO OPEN DRAIN

NOTE: IF TEMPERED WATER IS RECIRCULATED, RETURN LINE SHOULD BE CONNECTED AT POINT "A"

FOR MULTIPLE HEATER INSTALLATION SEE MANIFOLD KIT SPECIFICATIONS, PAGES 22-23

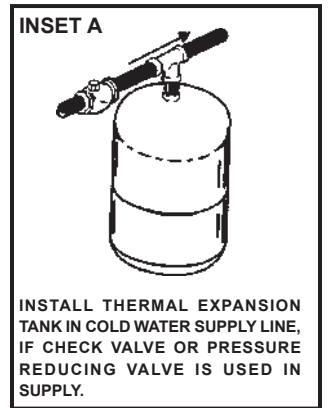
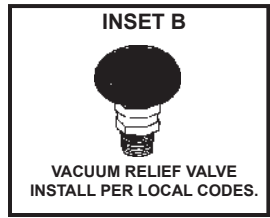

INSTALL IN ACCORDANCE WITH LOCAL CODES  
WIRING DIAGRAM FOR TEMPERED WATER LOOP (IF USED)

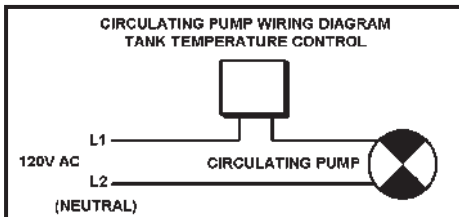

WIRING DIAGRAM FOR 180° LOOP (IF USED)

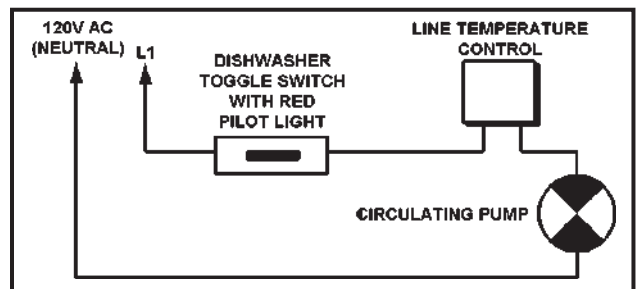

**TWO TEMPERATURE - THREE HEATERS (TWO PRE-HEATERS/ONE BOOSTER)  
WITH OR WITHOUT CIRCULATION**

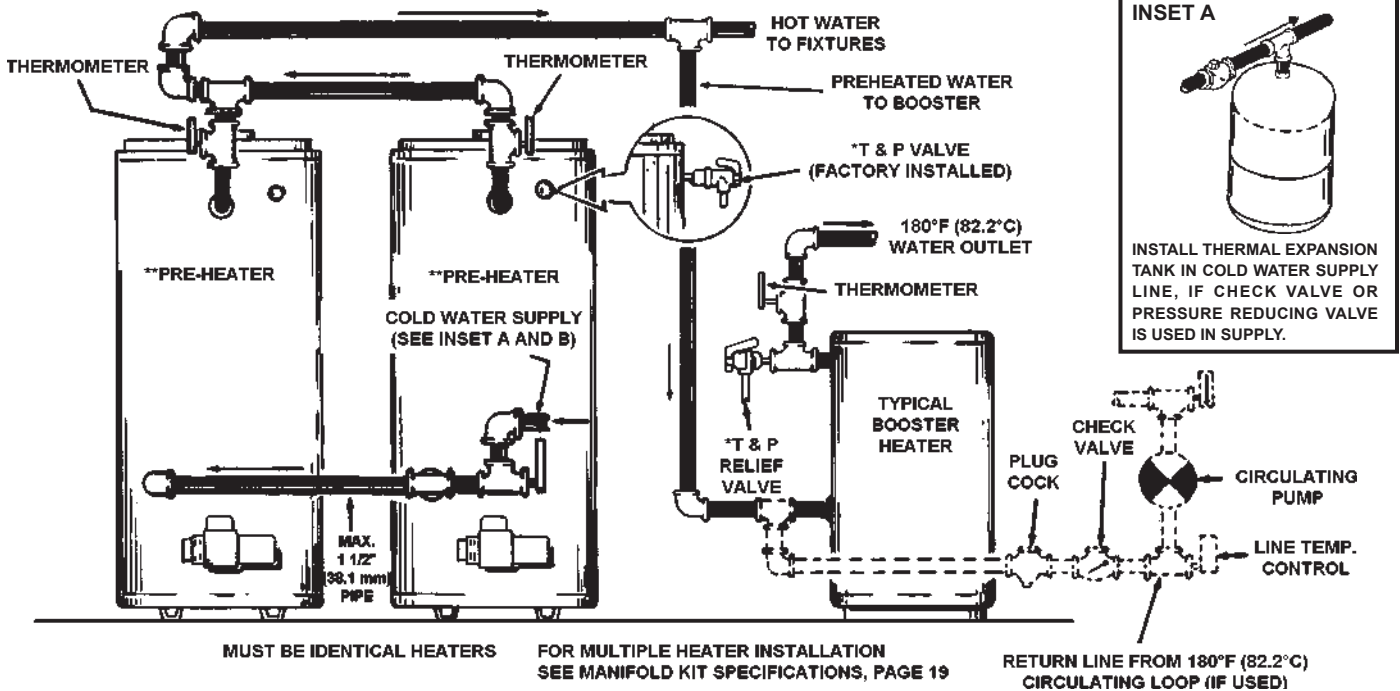

**⚠ DANGER:**  
TEMPERATURE SETTING SHOULD NOT EXCEED SAFE TEMPERATURES AT FIXTURES. SEE WATER TEMPERATURE CONTROL WARNING ON PAGE 11. IF HIGHER PREHEAT TEMPERATURES ARE NECESSARY TO OBTAIN ADEQUATE BOOSTER OUTPUT, ADD AN ANTI-SCALD VALVE FOR HOT WATER SUPPLIED TO FIXTURES.

**TWO TEMPERATURE - TWO HEATERS (ONE PRE-HEATER/ONE BOOSTER HEATER)  
WITH OR WITHOUT RECIRCULATION**

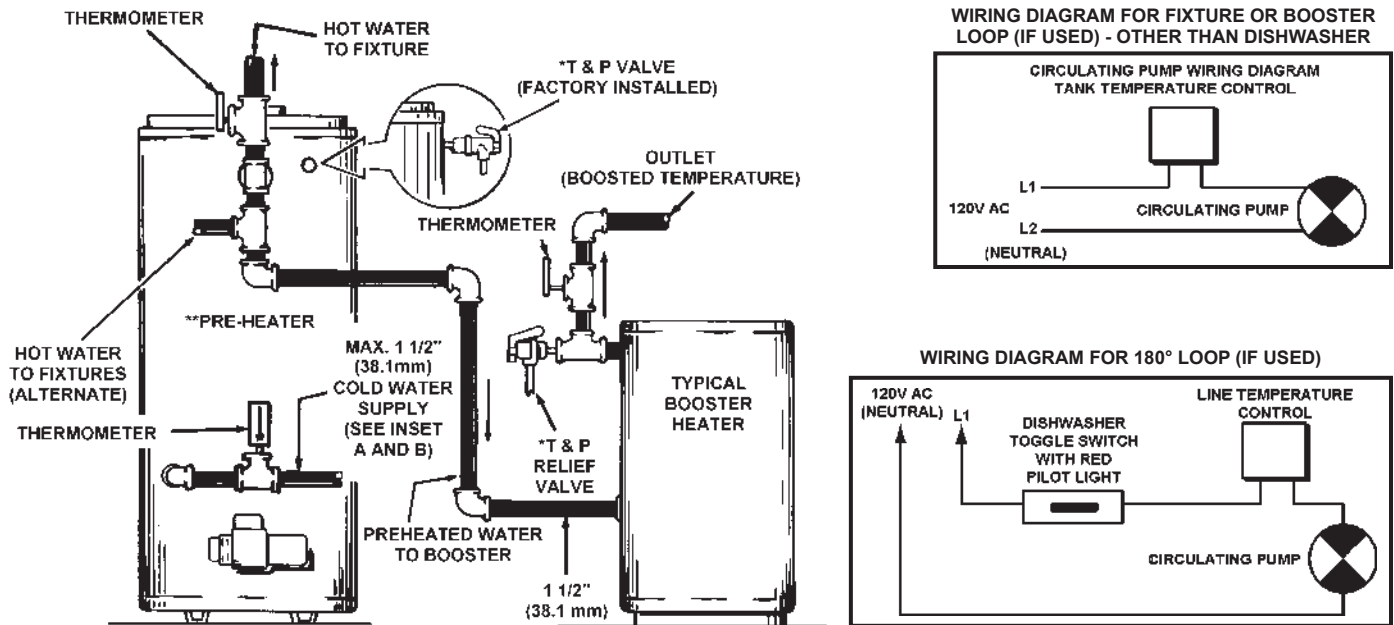

INSTALL IN ACCORDANCE WITH LOCAL CODES

\* PIPE RELIEF VALVE TO OPEN DRAIN

\*\* 140°F TO 150°F SHOULD BE MAXIMUM WATER TEMPERATURE MAINTAINED IN THE PRE-HEATERS.

120°F SHOULD BE THE MINIMUM TEMPERATURE OF WATER STORED IN THE PRE-HEATERS.

CONNECT CIRCULATING LINE FROM FIXTURES, IF USED, TO COLD WATER SUPPLY LINE OF PRE-HEATER.

CONNECT CIRCULATING LINE OF 180°F OR BOOSTED WATER, IF USED, TO INLET WATER LINE TO BOOSTER.

**TWO TEMPERATURE-ONE HEATER HIGH TEMPERATURE STORAGE  
WITH RECIRCULATION OF SANITIZING LOOP**

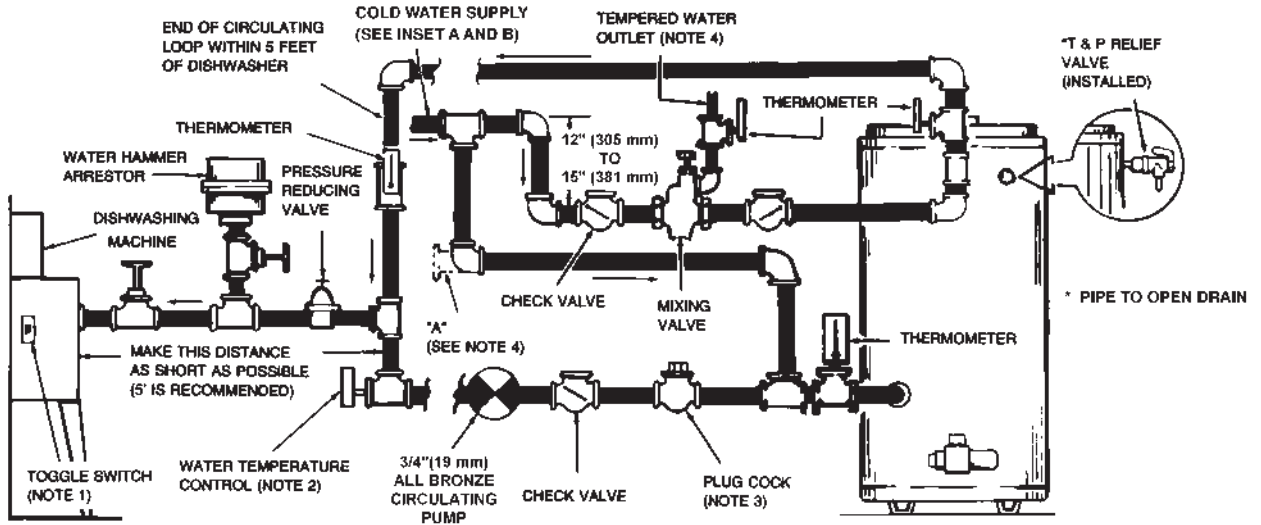

- NOTE 1: TOGGLE SWITCH CONTROLS 180°F WATER CIRCULATION. INSTALL ON OR CLOSE TO DISHWASHING MACHINE . TOGGLE SWITCH MUST BE CLOSED (ON) DURING THE RINSE OPERATION AND OPEN (OFF) WHEN DISHWASHER IS NOT OPERATING.
- NOTE 2: INSTALL LINE TEMPERATURE CONTROL IN AN UNINSULATED TEE BEYOND THE DISHWASHING MACHINE TAKEOFF IN THE SANITIZING LOOP. CONTROL SHOULD BE SET AT 185°F (85°C).
- NOTE 3: ADJUST PLUG COCK SO THE SANITIZING LOOP FLOW RATE DOES NOT CAUSE UNNECESSARY TURBULENCE IN THE TANK.
- NOTE 4: IF TEMPERED WATER IS RECIRCULATED, RETURN LINE SHOULD BE CONNECTED AT POINT "A".

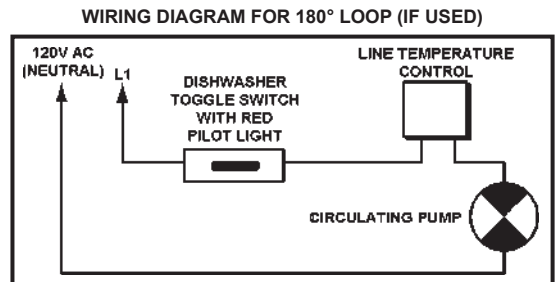
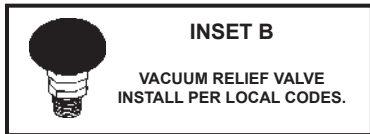
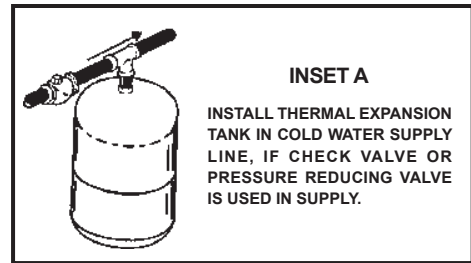

**NOTES**

---

## MANIFOLD KIT COMMERCIAL OIL FIRED WATER HEATERS

Precision cut type "L" all copper A.O. Smith manifold kits assure water flow balance of all units. Without this balance, the full water heating and storage potential of the system cannot be achieved. Plus, the units with the higher water flow may have a shortened life. Unions and T & P valves shown in piping diagrams are not included in the manifold kits.

Dimensions shown are for minimum space occupied by complete assemblies. Service space in front of units must be added.



**DANGER:**

**TEMPERATURE SETTING SHOULD NOT EXCEED SAFE TEMPERATURES AT FIXTURES. SEE WATER TEMPERATURE CONTROL WARNING ON PAGE 11. IF HIGHER PREHEAT TEMPERATURES ARE NECESSARY TO OBTAIN ADEQUATE BOOSTER OUTPUT, ADD AN ANTI-SCALD VALVE FOR HOT WATER SUPPLIED TO FIXTURES.**

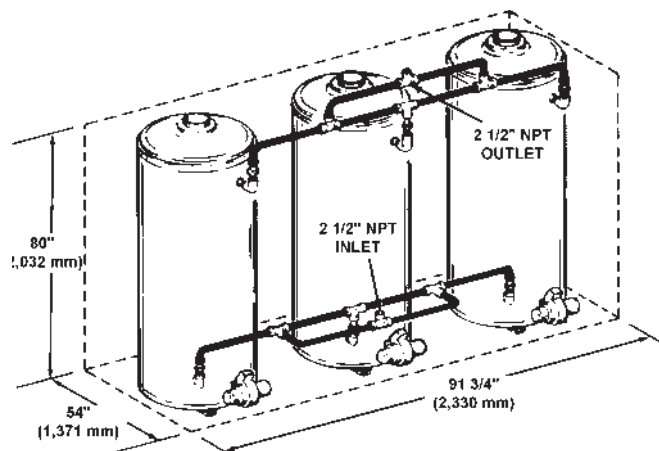

**THREE UNIT MANIFOLD KIT (PART NO. 9003427205)**

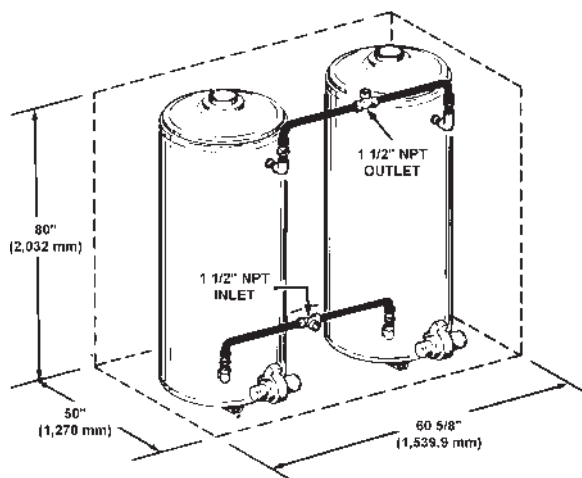

**TWO UNIT MANIFOLD KIT (PART NO. 9003426205)**

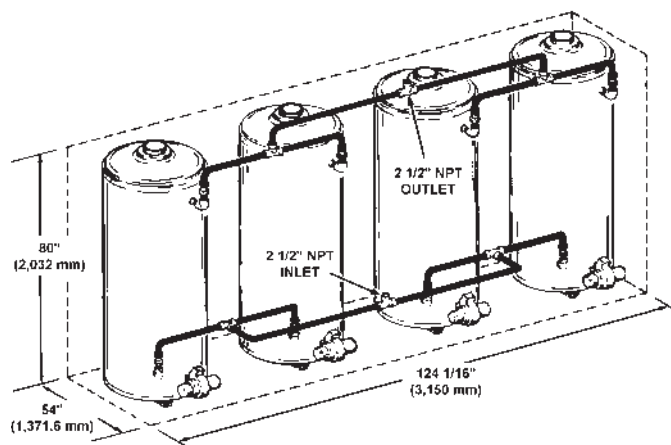

**FOUR UNIT MANIFOLD KIT (PART NO. 9003428205)**

## CHECK LIST AND SERVICE INFORMATION

### IMPORTANT

The installer may be able to observe and correct certain problems which might arise when the unit is put into operation or when it is refired after a prolonged shut-down. HOWEVER, it is recommended that only qualified servicemen, using appropriate test equipment, be allowed to service the heater.



**DANGER**

**BE SURE TO TURN OFF THE ELECTRICITY WHENEVER POSSIBLE OR APPROPRIATE WHEN CHECKING EQUIPMENT.**

### ELECTRICAL WIRING REPLACEMENT

If any of the original wiring, as supplied with the appliance, must be replaced, it must be replaced with 16 AWG, or greater, copper conductor with 600V, 105°C rated, thermoplastic insulation.

### NOT ENOUGH OR NO HOT WATER

1. Be certain the oil burner electrical disconnect switch serving the water heater is in the ON position.

2. Check the fuses.
  - The oil burner electrical disconnect switch usually contains fuses.
3. The capacity of the heater may have been exceeded by a large demand for hot water.
  - Large demands require a recovery period to restore water temperature.
4. Colder incoming water temperature will lengthen the time required to heat water to the desired temperature.
  - If the heater was installed when incoming water temperature was warm, colder water creates the effect of less hot water.
5. Look for hot water wastage and leaking or open hot water faucets.
6. Sediment or lime scale may be affecting water heater operation. Refer to MAINTENANCE for details.
7. Heater or burner may be dirty.
  - Clean all heater flue pipes and flue connector.
  - Have burner properly cleaned and readjusted.

8. Burner may not be firing at proper rate.
  - Check nozzle size.
  - Check fuel pump pressure setting.
  - COF-199 . . . . . 110 psig
  - All others . . . . . 100 psig
9. Burner may be short cycling. Short cycling (too frequent off and on) of burner will cause sooting. If unit or burner become dirty at frequent intervals, after correcting the dirt condition also correct the control settings (or other cause of the short cycling).
10. Oil burner fan wheel may be dirty.
  - Clean fan wheel with a stiff brush.
11. Draft regulator may be stuck.
  - Check to see if valve swings freely. Clean, if vane is stuck.
12. Priming control safety reset is open.
  - Reset safety switch on burner mounted primary control, see SAFETY PRIMARY CONTROL, page 22.
13. Burner motor safety reset is open.

### BURNER STARTS-WON'T OPERATE

1. No oil in tank.
2. Oil line valve closed.
3. Loose connection in primary control.
  - Check and tighten all wire connections, see SAFETY PRIMARY CONTROL, page 22.
4. Electrode out of adjustment.
  - Clean firing head and readjust electrodes.
5. Clogged burner nozzle.
  - Replace with new nozzle, see nozzle chart, page 9, table 8.
  - Nozzle should be replaced semiannually.
6. Dirty filter.
  - Replace element in oil filter.

### WATER IS TOO HOT

1. Refer to WATER TEMPERATURE, page 11.

### WATER HEATER MAKES SOUNDS

1. Sediment or lime scale accumulations cause noises when the tank bottom should be cleaned. Refer to MAINTENANCE, page 12-13 for details.
2. Some of the electrical components of the water heater makes sounds which are normal.
  - Contacts click or snap as the heater starts and stops.
  - Transformers often hum.

### WATER LEAKAGE IS SUSPECTED

1. Check to see if the water heater drain valve is tightly closed.
2. The apparent leakage may be condensation which forms on cool surfaces of the heater and piping.
3. If the outlet of the relief valve is leaking it may represent:

- Excessive water pressure.
- Excessive water temperature.
- Faulty relief valve.

Excessive water pressure is the most common cause of relief valve leakage. It is often caused by a "closed system". If a check valve is in the inlet system it will not permit the expanded hot water volume to equalize pressure with the main. The relief valve must release this water or the water heater or plumbing system will be damaged. This condition is not covered by the limited warranty. The solution is to add a thermal expansion tank between the check valve and the water heater.

### BURNER WON'T START

When the thermostat calls for heat but the burner won't start, check to make sure that you have proper voltage to the primary control.



**CAUTION**  
When checking the low voltage circuit at the control, DO NOT TOUCH THERMOSTAT WIRES TO FLAME DETECTOR TERMINALS AS THIS WILL BURN OUT THE SENSOR IN THE SAFETY PRIMARY CONTROL.  
If the voltage checks normal:

1. Flame detector may be sooted or seeing false light and will not let the motor replay pull in.
2. Loose wiring.
3. Bad flame detector (mounted inside housing beneath transformer).
4. Reset red safety button (primary control).
5. Defective primary control.
6. Reset motor protector.

### BURNER STARTS BUT FAILS TO RUN

When the burner starts (motor running) but flame is not established, the control will lock out on safety in about 15 seconds. If the control does not lock out on safety, then the control is defective and should be replaced. When the motor is running but flame is not established, then the problem becomes:

1. There is insufficient or no oil getting into the combustion chamber.
2. There is no spark to ignite the oil.

If the problem is insufficient or no oil getting into the combustion chamber, check for the following:

1. Dirt or water in the supply line.
2. Slipping coupling between motor and pump.
3. Defective pump.
4. Clogged, defective or too small a nozzle.
5. Oil tank empty.
6. Clogged filter in oil line.
7. Restriction or kink in fuel line.
8. Ice in fuel line.
9. Air leak in inlet connections.

If the problem is not getting a spark to ignite the oil, check for the following:

1. Loose wiring.
2. Bad ignition transformer.
3. Low voltage.
4. Crack in electrode porcelain insulators.
5. Electrodes carboned or out of adjustment.
6. Weak or no contact between bus bars and terminals of transformer.

### NORMAL START, BUT LOCKS OUT ON SAFETY

When the thermostat calls for heat and the burner starts normally but the locks out on safety after about 15 seconds:

1. Improper setting of combustion air (too much air).
2. Weak or dirty flame detector.
3. Improper positioning of flame detector.
4. Bad flame detector.
5. Wiring from flame detector to primary not continuous or not making good contact.
6. Bad safety primary control.
7. Clogged, defective or too small sized nozzle.

### SAFETY PRIMARY CONTROL

#### Normal Burner Cycle

Although a normal burner cycle does not create a service problem, it is important to know what happens to better understand the problem when the unit is not operating properly.

The instant the thermostat calls for heat, the flame detector sees darkness and causes the sensor to conduct current. When the sensor conducts current, the motor relay coil pulls in, starting the burner motor and energizing the ignition transformer through the motor relay contacts. At the same instant the motor relay coil pulls in, the safety heater is energized.

When flame is established, the resistance of the flame detector drops (providing the flame detector can see the flame properly) which causes the sensor to block the current. When the sensor blocks, the safety heater drops out of the circuit and the motor relay coil continues to hold in through a set of holding contacts on the motor relay until the thermostat is satisfied and the burner shuts down.

### FLAME FAILURE AFTER NORMAL IGNITION

If, for some reason, there is a flame out, the flame detector sees darkness which causes the sensor to conduct current and again energize the safety heater. In approximately 15 seconds the safety contact will open and shut down the burner. The safety contacts of the safety primary control are the manual reset type, which means that the red safety button must be reset before trying again for ignition. When this occurs, allow about 5 minutes for safety heater to cool before depressing the red safety button.

Depress red button one time only. If burner does not operate after depressing red button one time, check combustion chamber. If combustion chamber is soaked with oil the combustion chamber must be replaced.

Some of the possible reasons for flame failure after normal ignition has occurred are:

1. Dirt or water in the supply line.
2. Pump losing prime.
3. Bad motor.
4. Erratic or low pressure at fuel pump.
5. Defective pump.
6. Loose wiring or connections.
7. Clogged or damaged nozzle.
8. Oil tank empty.
9. Oil tank not vented.
10. Clogged filter in oil line.
11. Ice in fuel line.

## COMBUSTION TEST SPECIFICATIONS

### GENERAL

A combustion test kit, capable of testing CO<sub>2</sub> content, stack temperature, draft and smoke must be available to aid in adjusting the unit and filling out the Oil Burner Certificate. A pressure gauge is needed to measure and adjust oil pump pressure.

### PROCEDURE

1. Check nozzle size, see table on page 9.
2. Open air band about halfway and being certain heater is filled with water, start burner.
3. Check oil pump pressure. It should be 110 psig for the COF-199 and 110 psig for all other models. Adjust setting as necessary.
4. Allow burner to operate for 15 minutes before proceeding with test.
5. After 15 minutes operation, check the draft in chimney connector, about halfway between the heater and the draft regulator and adjust the draft regulator until the correct reading is obtained.

Draft in Chimney after 15 minutes	Reading should be between -0.03 & -0.05 of Water
-----------------------------------	--

6. Adjust air band until flame has smoky tips. Immediately increase air supply until the smoky tips just appear.
7. Using combustion test kit, check smoke density and CO<sub>2</sub> in the chimney connector.

Smoke Density	Preferably No. 1 Spot (Not Over No. 2 Spot)
CO <sub>2</sub>	9% to 12%

- Adjust air supply with air band to achieve the highest CO<sub>2</sub> readings with an acceptable smoke density reading. Test and readjust as necessary.
8. Check the stack temperature halfway between the heater and the draft regulator.

Stack Temperature	Min.	400° F (204°C)
	Max.	600° F (315°C)

- If stack temperature is too high, check for a soot accumulation in heater or excessive oil pump pressure.
9. Recheck combustion efficiency against specifications when final adjustments have been made.

# TROUBLESHOOTING

**TABLE 10 - OIL BURNER TROUBLESHOOTING**

TROUBLE	CAUSE	REMEDY
<b>No Oil Flow at Nozzle</b>	Oil level below intake line in supply tank.	Fill tank with oil.
	Clogged strainer or filter.	Remove and clean strainer. Replace filter element.
	Clogged nozzle.	Replace nozzle.
	Air leak in intake line.	Tighten all fittings in intake line. Tighten unused intake port plug. Check filter cover and gasket.
	Restricted intake line. (High vacuum reading).	Replace any kinked tubing and check any valves in intake line.
	A two line pipe system that becomes air bound.	Check for and insert by-pass plug. Make sure return line is below oil level in tank.
	A single line pipe system that becomes air bound.	Loosen gauge port plug or air bleed valve and bleed oil for 15 seconds after foam is gone in bleed hose, Check intake line fittings for tightness. Check all fuel pump plugs for tightness.
	Slipping or broken coupling.	Replace coupling.
	Rotation of motor and fuel unit pump is not the same as indicated by arrow on the pad at top of unit.	Install fuel pump with correct rotation.
	Frozen fuel pump shaft.	Replace fuel pump. Check for water and dirt in tank.
<b>Oil Leak</b>	Loosen plugs and fittings.	Tighten with good quality thread sealer.
	Leak at pressure adjusting screw or nozzle plug.	Replace fuel pump.
	Blown seal (single-pipe system)	Check to see if by-pass plug has been left in fuel pump. Replace fuel pump.
	Seal leaking.	Replace fuel pump.
	Cover.	Tighten cover screws.
<b>Noisy Operation</b>	Bad coupling alignment.	Loosen fuel pump mounting screws slightly and shift fuel pump in different positions until noise is eliminated. Retighten mounting screws.
	Air in inlet line.	Check all connections. Use only good flare fittings.
	Tank turn on two line pipe system and inside tank.	Install return line hum eliminator.
<b>Low Oil Pressure</b>	Partially clogged strainer or filter.	Remove and clean strainer.
	Air leak in intake line.	Tighten all fittings.
	Air leaking around cover.	Be sure strainer cover screws are tightened securely. Check for damaged cover gasket.
<b>Improper Nozzle Cut-Off</b>	Defective gauge	Check gauge against master gauge or other gauge.
	Nozzle capacity is greater than fuel pump capacity.	Replace fuel unit with unit of correct capacity.
	To determine the cause of improper cut-off, insert a pressure gauge in the nozzle port of the fuel pump. After a minute of operation, shut burner down. If the pressure drops from normal operating pressure and stabilizes, the fuel pump is operating properly and air is the cause of improper cut-off. If, however, the pressure drops to 0 psi, fuel unit should be replaced. NOTE: Never use the amount of pressure drop as an indication of the quality or speed of cut-off.	
	Filter leaks.	Check face of cover and gasket for damage.
	Strainer cover loose.	Tighten 4 screws on cover.
	Air pocket between cut-off valve and nozzle.	Run burner, stopping and starting unit, until smoke and after-fire disappears.
	Air leak in intake line.	Tighten intake fittings. Tighten unused intake port and return plug.
Partially clogged nozzle strainer.	Clean strainer or change nozzle.	
Leak at nozzle adaptor.	Change nozzle and adaptor.	

# COMMERCIAL WATER HEATER LIMITED WARRANTY



## EFFECTIVE

For 3 Years, in the event of a tank leak, we will repair or, at our discretion, replace the defective water heater.

For 1 Year, in the event of part failure, we will repair or, at our discretion, replace the defective part.

We warrant this product against defects in materials or workmanship as described in this document if installed within the United States or Canada and provided the product remains at its original place of installation.

Warranty coverage begins the date of installation OR the date of manufacture if installation cannot be verified.

## WHAT'S COVERED

Subject to these terms, in the event of defect in materials and/or workmanship resulting in a **tank leak** during the **first three years**, we will:

- Replace the water heater should the tank leak.

Subject to these terms, in the event of a defect in materials and/or workmanship appearing during the **first year**, we will:

- Repair or, at our discretion, replace any part of the water heater covered under this limited warranty excluding parts subject to normal maintenance (Example: non-electronic anode rod, filter, etc)

**Service/labor, shipping, delivery, installation, handling or any other costs are not covered at any time under this warranty.**

Any replacement part or product will be warranted only for the unexpired portion of the original water heater's limited warranty period.

If an identical model is no longer available due to a change in law, regulation, or standard, we will replace the product with one having comparable capacity and input. In these instances, the owner will have the option of paying the difference between what was paid for the original model and the new model with the additional features, or receiving a refund of the portion of the purchase price, on a pro-rata basis allocable to the unexpired portion of the warranty.

## WHAT'S NOT COVERED

- Problems caused by improper: gas supply line sizing, gas type, venting, connections, combustion air, voltage, wiring, or fusing
- Failure to follow applicable codes
- Failure to follow printed instructions
- Abuse, misuse, accident, fire, flood, Acts of God
- Improper installation, sizing, delivery, or maintenance
- Claims related to rust, noise, smell, or taste of water
- Failure to conduct authorized factory start up if required
- Alterations to the water heater
- Non-outdoor heaters installed outdoors
- Damages due to a failure to allow for thermal expansion
- Heat exchanger failure due to lack of adequate / proper supply of water
- Heaters moved from their original location
- Service trips to explain proper installation, use, or maintenance of the product/unit or to describe compliance requirements under applicable codes and regulations
- Charges related to accessing your heater including but not limited to door/wall removal, equipment rental, etc.
- Replacement parts after expiration of this warranty

## LIMITATIONS

NOTWITHSTANDING ANYTHING ELSE TO THE CONTRARY, THIS IS YOUR SOLE AND EXCLUSIVE WARRANTY. ALL OTHER WARRANTIES INCLUDING A WARRANTY OF MERCHANTABILITY OR FITNESS FOR PARTICULAR PURPOSE ARE EXPRESSLY DISCLAIMED. SELLER SHALL NOT BE LIABLE FOR ANY CONSEQUENTIAL, INCIDENTAL, SPECIAL, PUNITIVE OR OTHER INDIRECT DAMAGES. TOTAL LIABILITY ARISING AT ANY TIME SHALL NOT EXCEED THE PURCHASE PRICE PAID WHETHER BASED ON CONTRACT, TORT, STRICT LIABILITY OR ANY OTHER LEGAL THEORY.

## SERVICE INQUIRIES:

For service inquiries call the telephone number listed below. Be prepared to provide the following information: name, address, and telephone number; the model and serial number of the water heater; proof of installation; and a clear description of the problem.

For your records, fill in the product:

Serial: \_\_\_\_\_

Model: \_\_\_\_\_

U.S. Customers:

**A. O. Smith Corporation**  
500 Tennessee Waltz Parkway  
Ashland City, Tennessee 37015  
800-527-1953  
[www.hotwater.com](http://www.hotwater.com)

Canadian Customers:

**P. O. Box 310 – 768 Erie Street**  
Stratford (Ontario) N5A 6T3  
800-265-8520



**COMMERCIAL WATER HEATER PARTS LIST**  
**MODEL COF - 199, 245, 315, 385, 455 & 700**  
**AND COF - 315A, 385A, 455A & 700A**  
**SERIES 940/941**

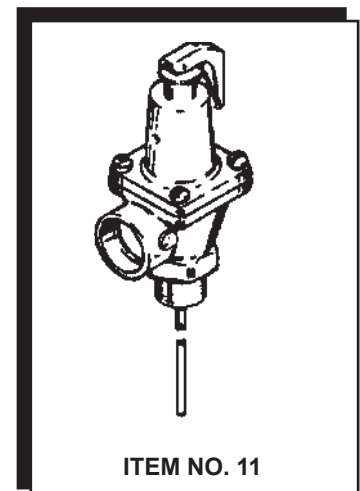
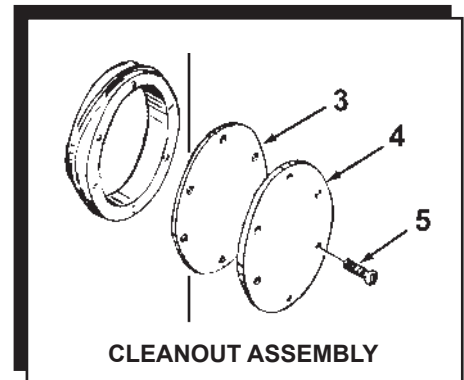
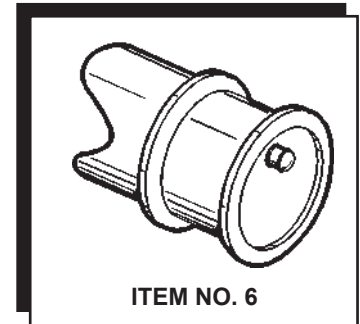
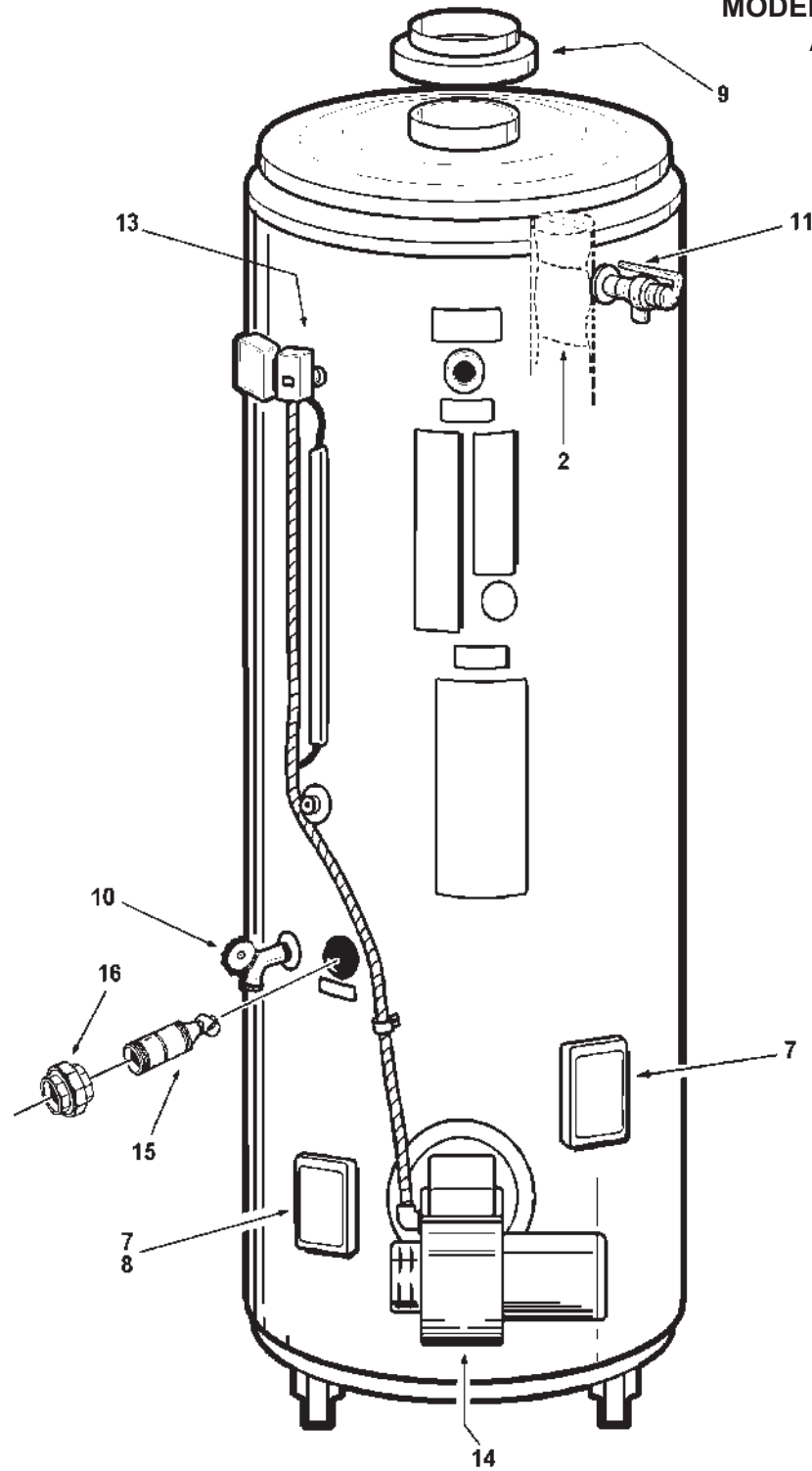

**A.O. SMITH**  
 500 Tennessee Waltz Parkway  
 Ashland City, TN 37015  
 1-800-433-2545  
[www.hotwater.com](http://www.hotwater.com)

ITEM	DESCRIPTION	COF	COF	COF	COF	COF	COF
		199	245	315	385(A)	455(A)	700(A)
1	*Anode, .....	9003892005(2) ...	9003892005(2) .....	9003892005(2) .....	9003892005(3) .....	9003892005(3) .....	9003892005(4)
2	Baffle, Flue .....	9005341205(6) ...	9005341205(6) .....	9005341205(7) .....	191996-1(12) .....	9005341205(12) ...	9005341205(16)
<b>CLEANOUT ASSEMBLY</b>							
3	Gasket .....	9004099215 .....	9004099215 .....	9004099215 .....	9004099215 .....	9004099215 .....	9004099215
4	Pressure Plate .....	9005797205 .....	9005797205 .....	9005797205 .....	9005797205 .....	9005797205 .....	9005797205
5	Screw-self Tapping .....	9004100215 .....	9004100215 .....	9004100215 .....	9004100215 .....	9004100215 .....	9004100215
6	Barometric Draft Control .....	9500007099 .....	9500007100 .....	9500007100 .....	9500007100 .....	9500007100 .....	9500007101
7	Cover, Cleanout Opening & Observation Port .....	181260 .....	181260 .....	181260 .....	181260 .....	181260 .....	181260
8	Plug, Observation .....	41377-1 .....	41377-1 .....	41377-1 .....	41377-1 .....	41377-1 .....	41377-1
9	Reducer, Flue .....	99767-2 .....	.....	.....	.....	.....	76707-1
10	Valve, Drain .....	9003906015 .....	9003906015 .....	9003906015 .....	9003906015 .....	9003906015 .....	9003906015
11	Valve, Relief .....	9005899205 .....	9005903205 .....	9005903205 .....	9005903205 .....	9005903205 .....	9006187205
12	*Instruction Manual .....	193472-2 .....	193472-2 .....	193472-2 .....	193472-2 .....	193472-2 .....	193472-2
13	Thermostat with E.C.O. ....	9006543005 .....	9006543005 .....	9006543005 .....	9006543005 .....	9006543005 .....	9006543005
14	Oil Burner Single Stage .....	9500007239 .....	9500007241 .....	9500007243 .....	9500007248 .....	9500007250 .....	9500007252
	Two Stage .....	9500007240 .....	9500007242 .....	9500007244 .....	9500007249 .....	9500007251 .....	9500007253
15	Hydro-Cannon .....	9006052205 .....	9006052205 .....	9006052205 .....	9006052205 .....	9006052205 .....	9006052205
16	1 1/2" Pipe Union .....	9006053205 .....	9006053205 .....	9006053205 .....	9006053205 .....	9006053205 .....	9006053205

\* Not Illustrated

Quantities shown in parenthesis next to part number.  
Request parts from Product Service Division giving all information such as model and series number.

---

NOTES



500 Tennessee Waltz Parkway  
Ashland City, TN 37015  
[www.hotwater.com](http://www.hotwater.com)